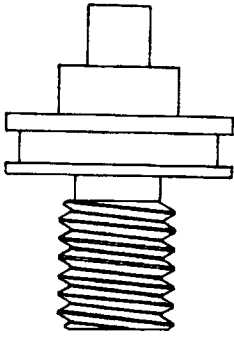
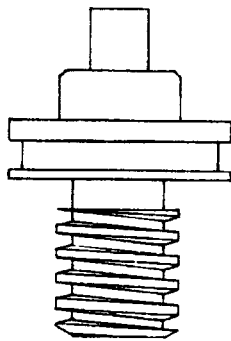

TABLE OF CONTENTS
Hydrant Section

Operating screws.....2-4
Operating blocks..... 5
Plungers..... 6-7
Vacuum breaker kits..... 8
Head nuts..... 9
Smith repair kits..... 11-12
Prier repair kits..... 13
Josam repair kits..... 14-15
Wade repair kits..... 16-19
Woodford repair kits..... 20-22
Zurn repair kits..... 23-24
Josam..... 25-28
J.R. Smith..... 29-32
Mansfield..... 33-34
Nibco..... 35-37
Watts..... 38-43
Wade..... 44-46
Woodford..... 47-53
Zurn..... 54-57



95001
Smith old style
fine thread
operating screw
11569 o-ring
22015 key



95002
Smith coarse thread
operating screw
11569 o-ring
22015 key

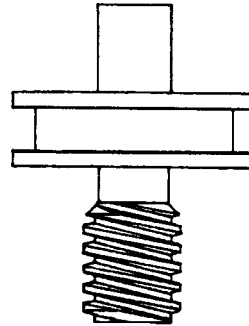

95003
Zurn operating screw
for model Z-1385
11572 o-ring
22016 key

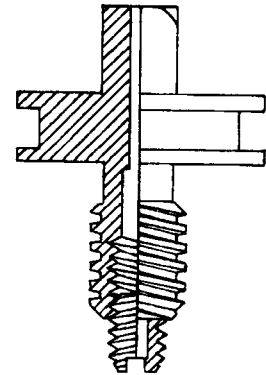

95003A
Zurn operating screw
for model Z-1300
11572 o-ring
22016 key

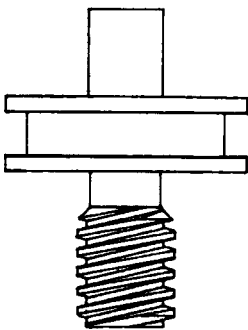

95011
Old style Zurn re-
verse thread operat-
ing screw
11572 o-ring
22016 key

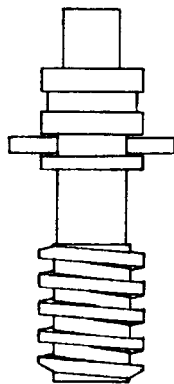

95004
Wade, Prier
operating screw
11508 o-ring
22015 key

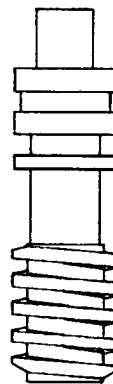

95032
replacement for Josam
operator model Y-210
11572 o-ring
22016 key

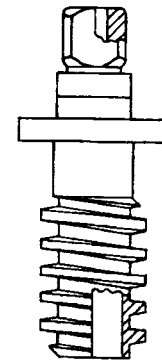

95062
Woodford stem screw
22016 key

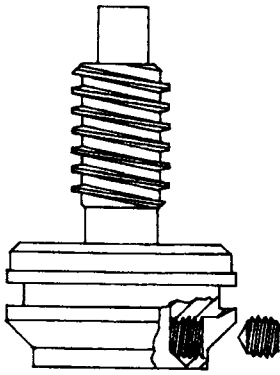

95006
Josam actuator for
Hydrasan I & II
11544 o-ring
22014 key

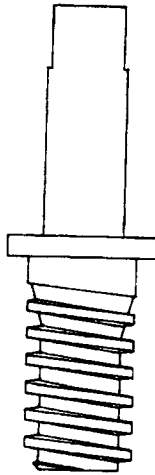

95009
Wade, Prier, Josam
worm stem
22015 key

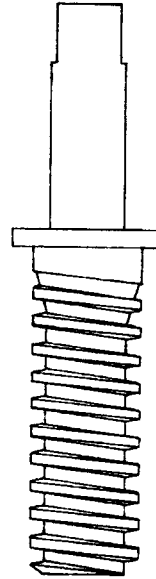

95007
Wade, Prier, Josam
worm stem

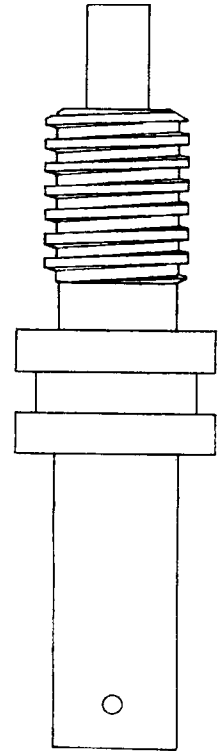

95008
Josam, Greenberg old
style operating stem

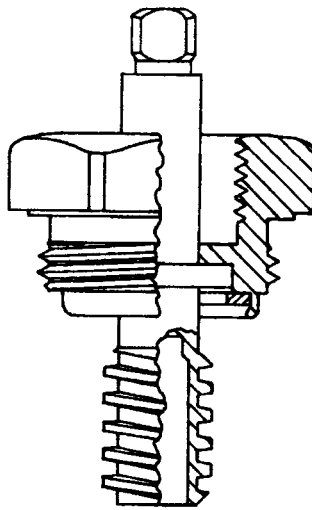

94110
Woodford head nut
assembly

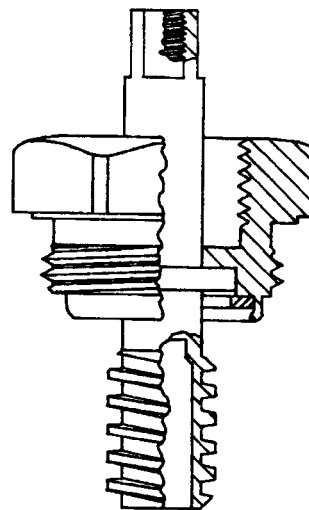

94059
Woodford head nut
assembly

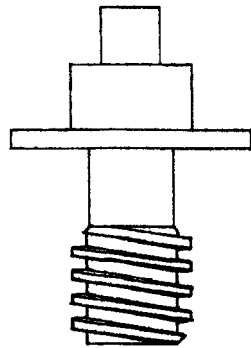

95030
Smith coarse thread
operating screw
22015 key

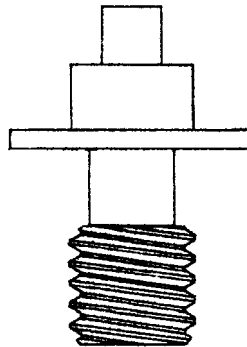

95031
Smith fine thread
operating screw
22015 key

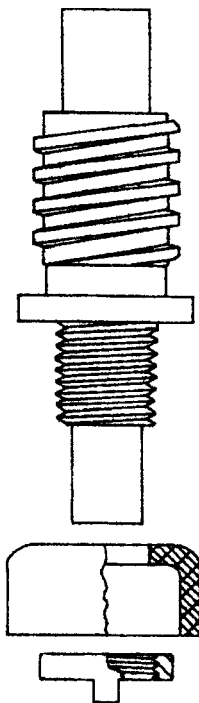

95033
Eclipse old style
operating stem

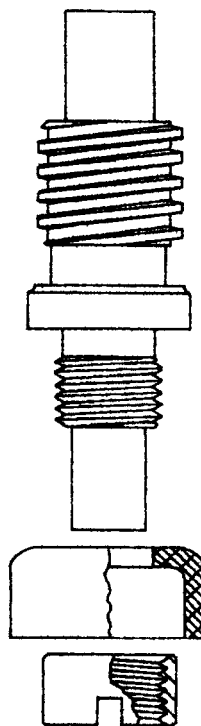

95034
replacement for
Zurn old style oper-
ating stem

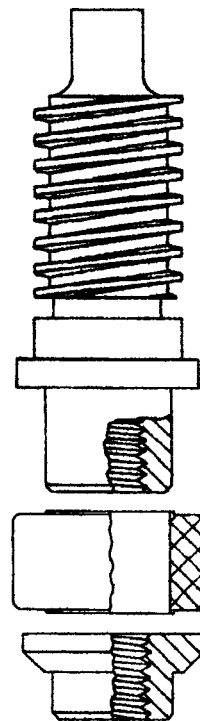

95035
replacement for Josam
operating stem for
model Y-200

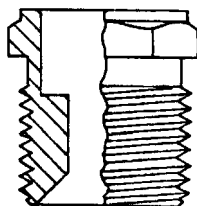

95112
new style Wade, Prier,
Josam worm sleeve
11568 o-ring

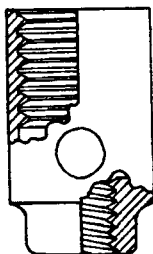

95101
Smith old style fine
thread block

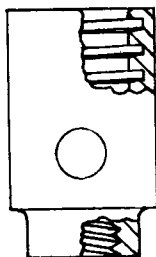

95102
Smith coarse
thread block

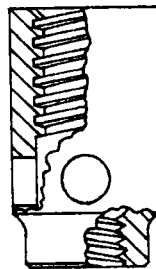

95103
Zurn #7 block

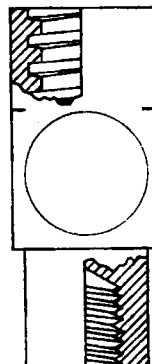

95110
Wade, Prier, Josam
worm sleeve

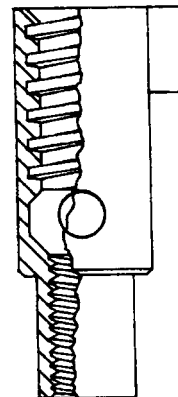

95014
Woodford
yoke nut

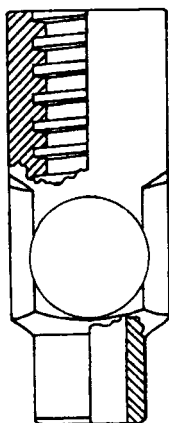

95107
3/8" sweat
worm sleeve

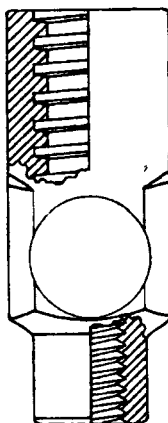

95108
3/8" thread
worm sleeve

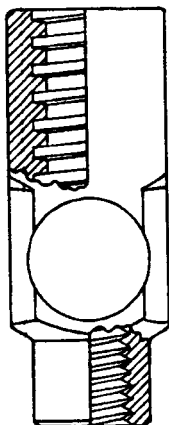

95109
7/16" thread
worm sleeve

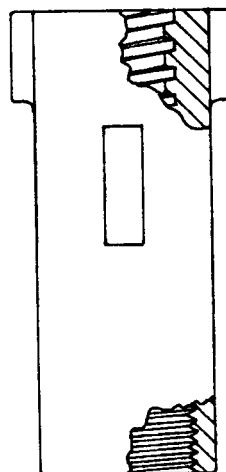

94109
Woodford yoke
nut

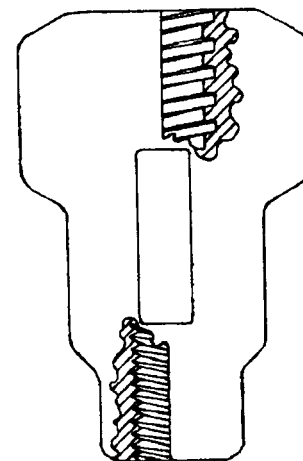

95104
Wade worm
sleeve



94400
Zurn soft
plunger

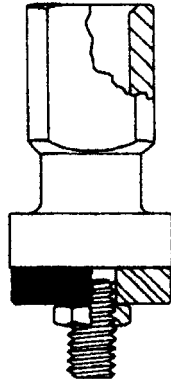

95113
Zurn old style
plunger

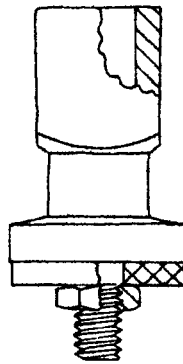

95114
Eclipse old
style plunger

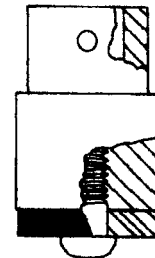

95111
replacement for
Josam plunger

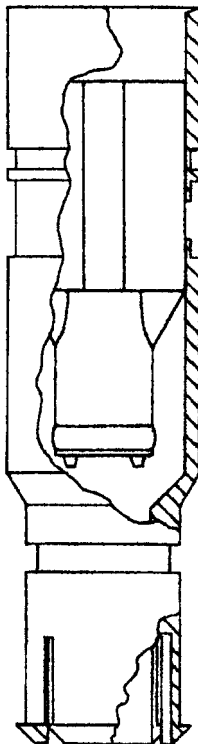

95023
new style
plunger with
plastic sleeve
includes 95022

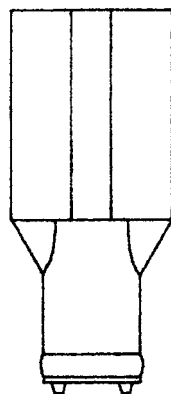

95022
Wade, Prier
new style
plunger

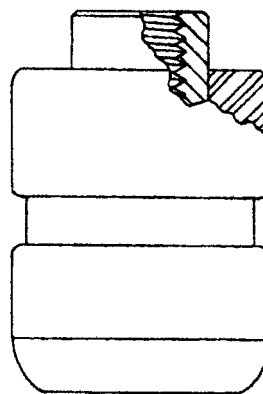

95018
Wade plunger

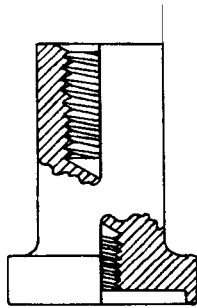

95000
Smith plunger

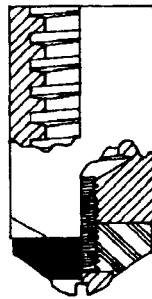

95020
Wade plunger

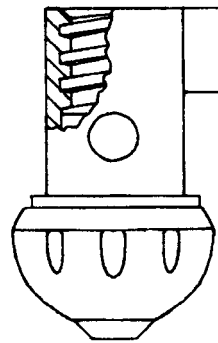

94105
Woodford yoke
& nut assembly

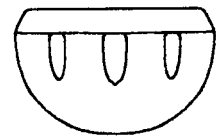

95017
Woodford
plunger seat

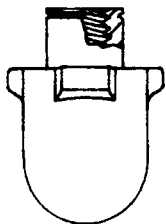

95015
Woodford
plunger

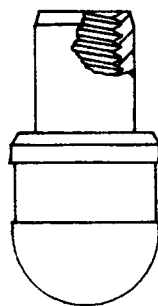

95016
Woodford
plunger

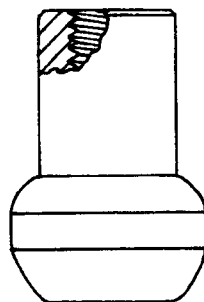

95012
Wade, Prier,
Josam plunger

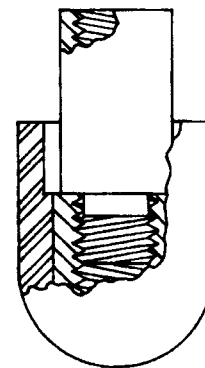

95013
two piece
Wade, Josam
plunger

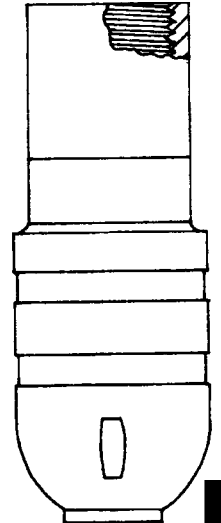

95014
Woodford
plunger

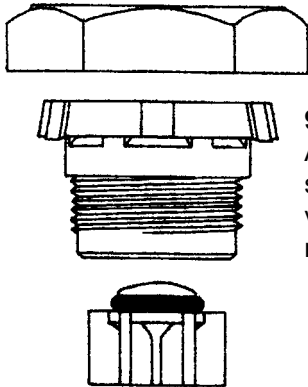

94401
Arrowhead #420
series frost free
vacuum breaker
repair kit

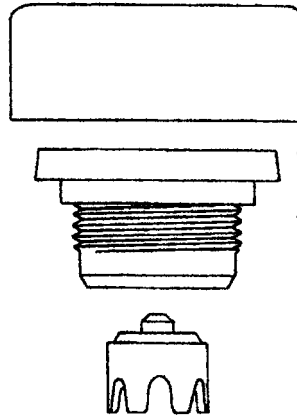

94402
Mansfield models
frost free vacuum
breaker kit

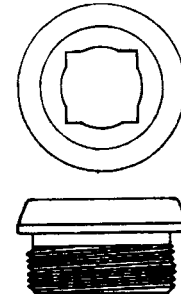

95024
Smith brass seat
15/16" x 3/4" - 27
thread

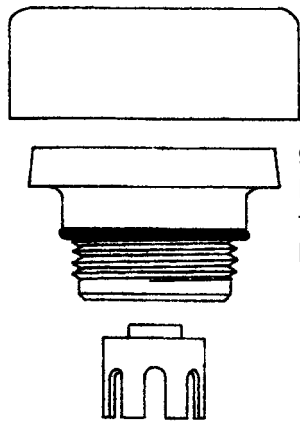

94403
Nibco model #90
frost free vacuum
breaker kit

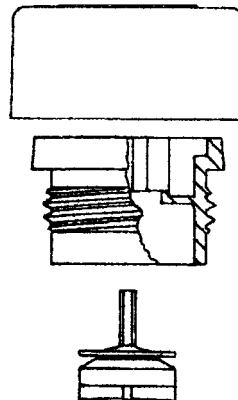

94404
Woodford model
#17 frost free
vacuum breaker kit

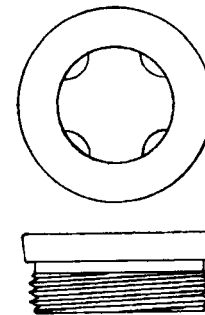

95026
Wade, Josam, Prier
nylon seat
3/16" x 1" - 22 thread

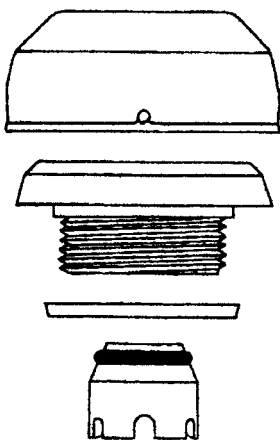

94405
Smith #5509QT
frost free vacuum
breaker repair kit

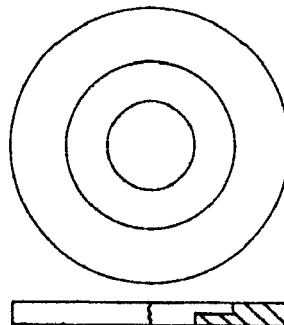

95202
Wade, Josam, Prier
commercial vacuum
breaker diaphragm

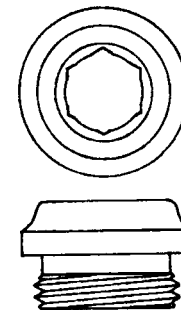

95025
Zurn brass seat
9/16" x 3/4" - 16
thread

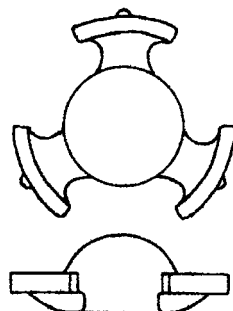

95203
Wade, Josam, Prier
commercial vacuum
breaker check "spider"

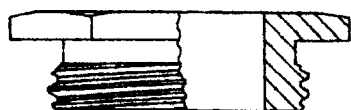

94406
Zurn head nut

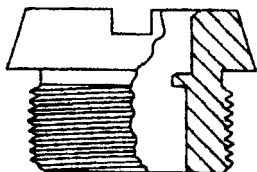

94407
Smith hose bibb
face nut

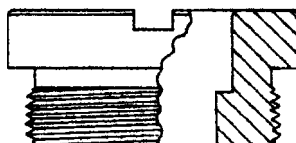

94408
Smith wall hydrant
face nut

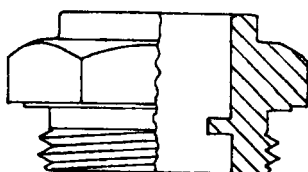

94254 brass
94253 chrome
Woodford head nut

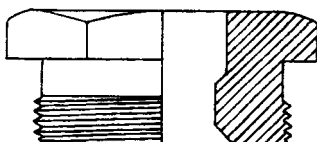

95053 brass
95054 chrome
Wade, Josam, Prier
stem bushing nut

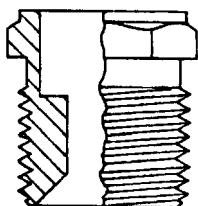

94112 brass
94111 chrome
Woodford packing
nut assembly

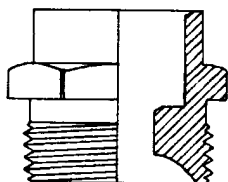

95057 brass
95058 chrome
Wade, Josam, Prier
packing nut

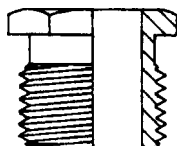

95059
Wade yard hydrant
packing nut

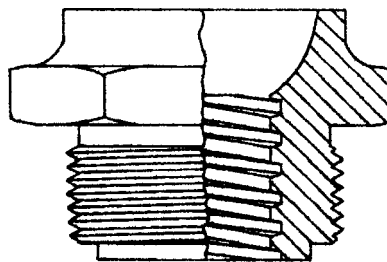

95064
old style Eclipse
head nut

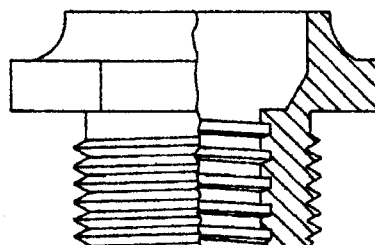

95063
old style Zurn
head nut

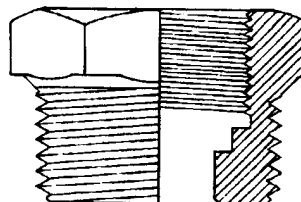

95050 brass
95051 chrome
Wade, Josam, Prier
worm nut

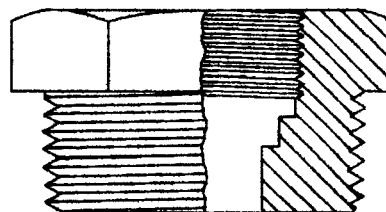

95052
Wade worm nut
models #8609 &
#8610 (1" & 1-1/4")

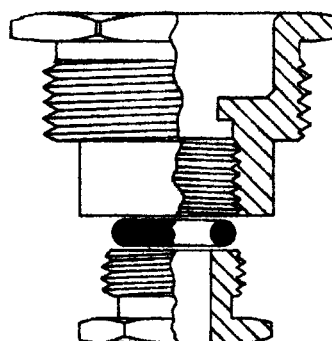

95061
replacement Josam
model Y-210 head
nut

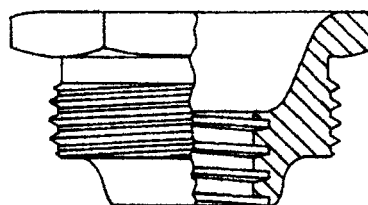

95062
replacement Josam
model Y-200 head
nut

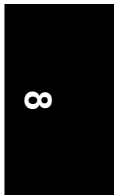

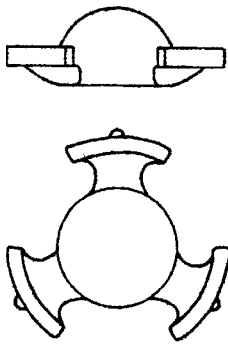

95203
Wade, Josam
diverter check "spi-
der"

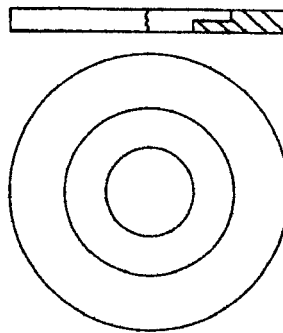

95202
Wade, Josam
diverter diaphragm

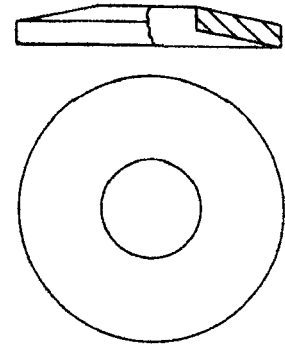

94854
Zurn "Equa-Balance"
seal

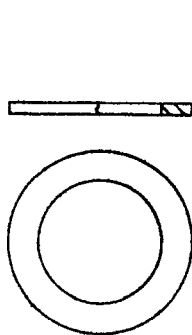

95129
Wade, Josam, Prier
retaining washer

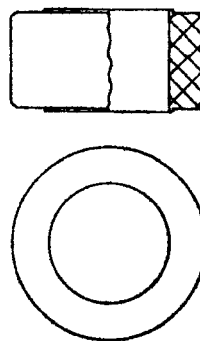

95127
Wade, Josam, Prier
drain port sleeve

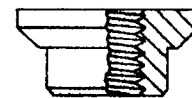

95135
Wade, Josam, Prier
rod adapter

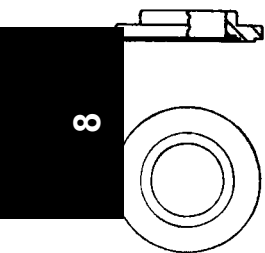

94252
Woodford
stem washer

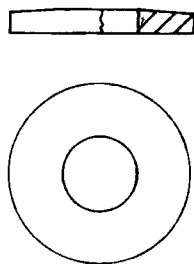

95125
Wade, Josam,
Prier packing
washer

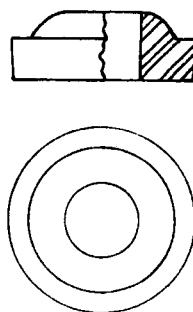

95131
Wade, Josam,
Prier packing

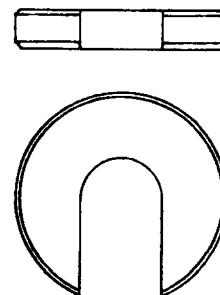

94251
Woodford
"C" washer

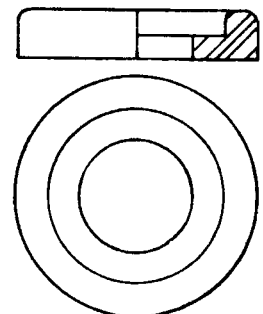

95126
Wade, Josam,
Prier nylon
retaining seal

95343
replacement for
Smith #HPRK-21

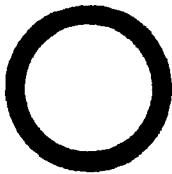
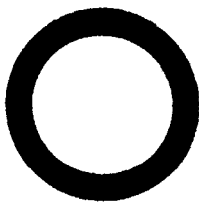
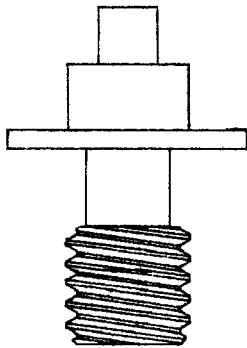

95344
replacement for
Smith #HPRK-41

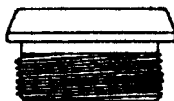
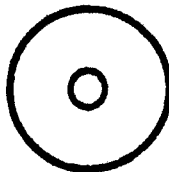
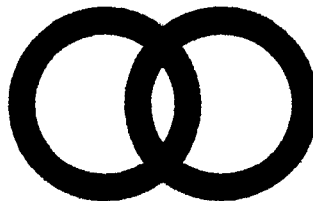
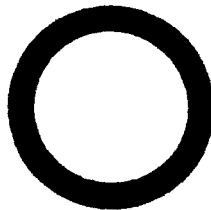
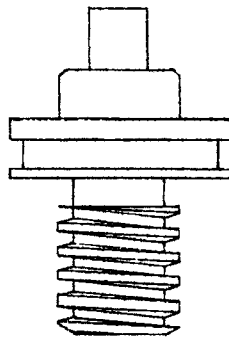

95345
replacement for
Smith #HPRK-42

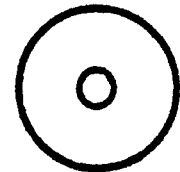
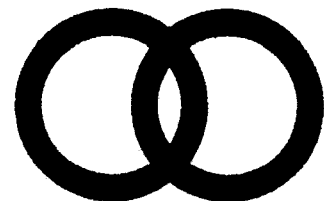
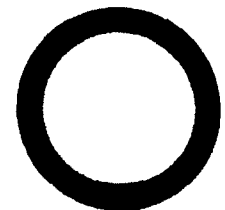
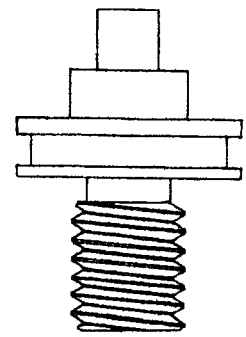

95340
replacement for
Smith #HPRK-2

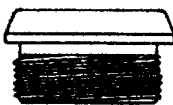
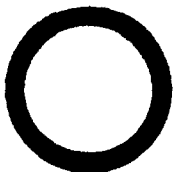
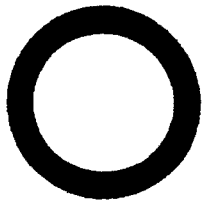
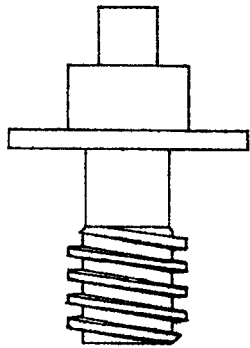

95341
replacement for
Smith #HPRK-11

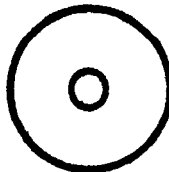
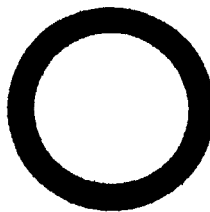
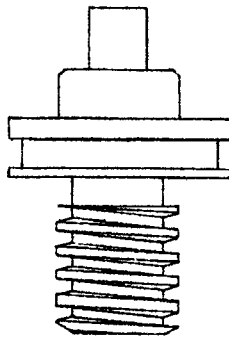

95342
replacement for
Smith #HPRK-12

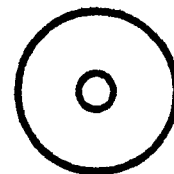
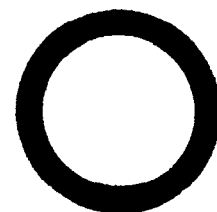
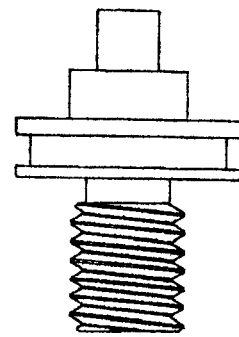

95330
replacement for
Prier #C-634KTI

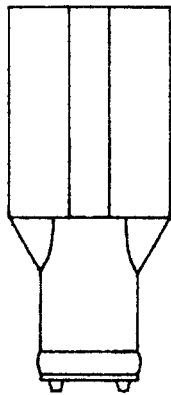
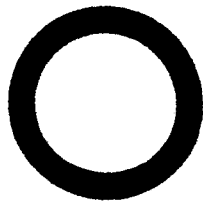
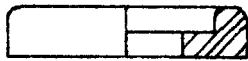

95331
replacement for
Prier #C-634KT2

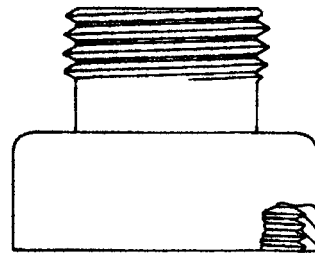
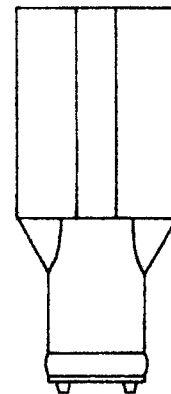
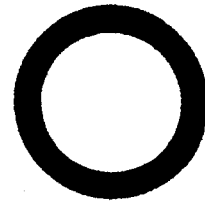
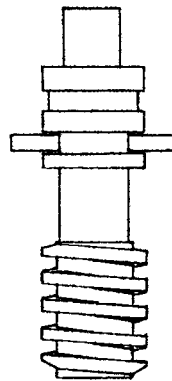
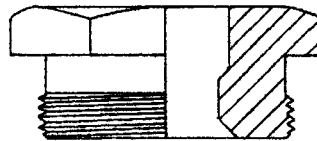

95324
replacement for
Josam #14

95325
replacement for
Josam #15

95326
replacement for
Josam #21

95327
replacement for
Josam #22

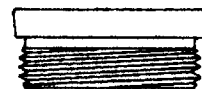
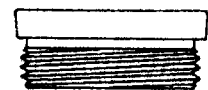
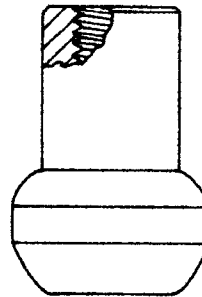
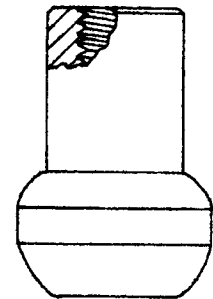
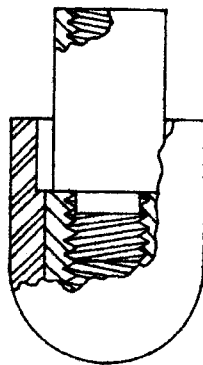
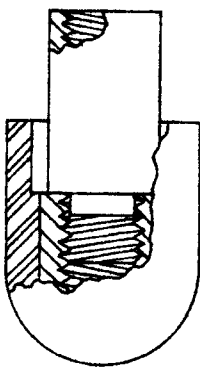
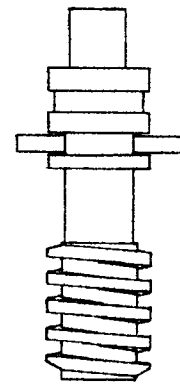
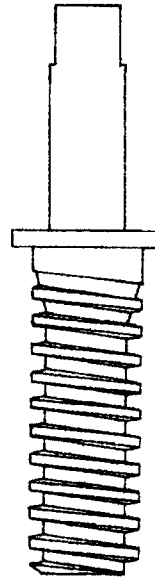
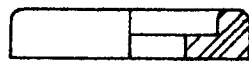
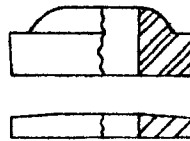
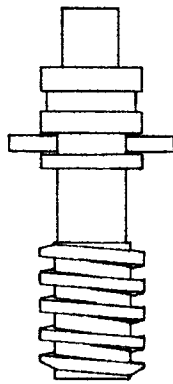
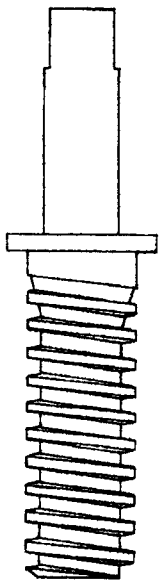
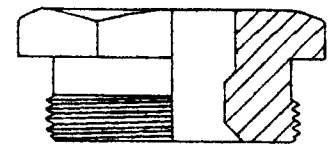
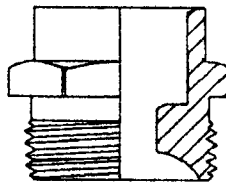
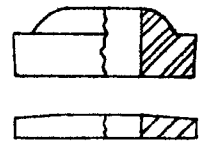

95320
replacement for
Josam #1

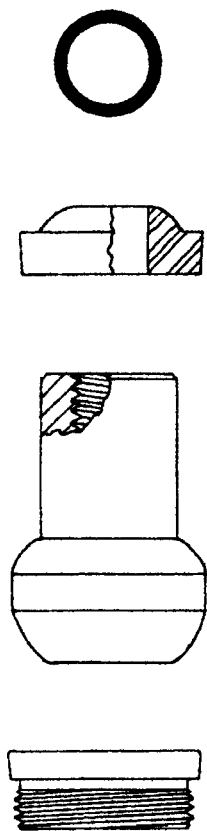

95321
replacement for
Josam #4

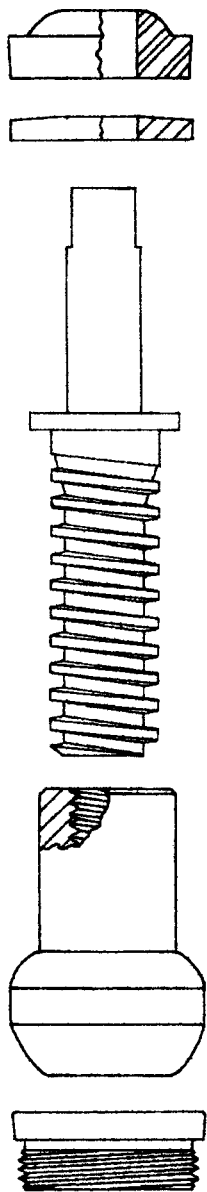

95322
replacement for
Josam #5

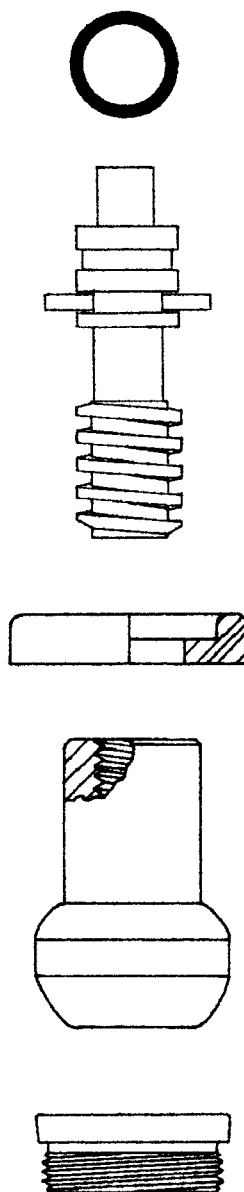

95323
replacement for
Josam #8

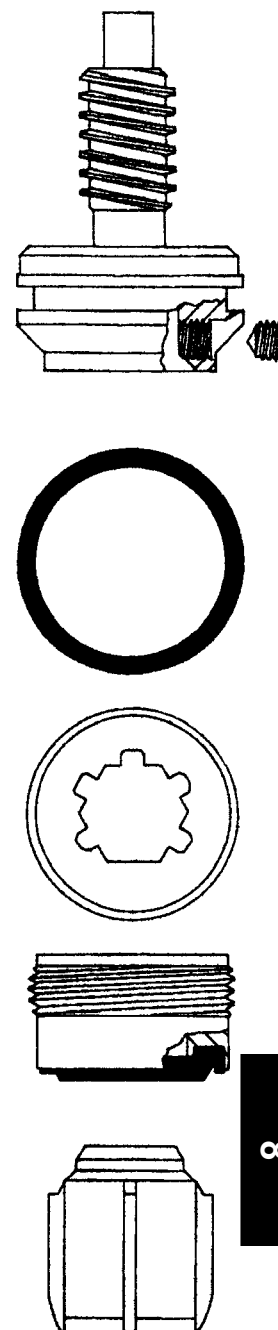

95360
replacement for
Wade #WKO1

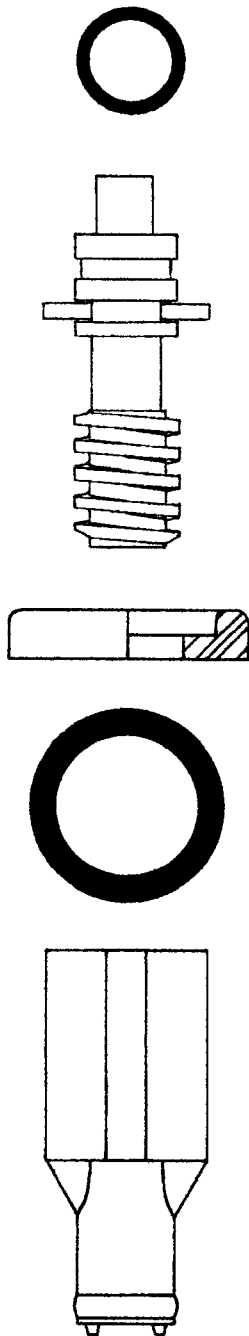

95361
replacement for
Wade #WKO2

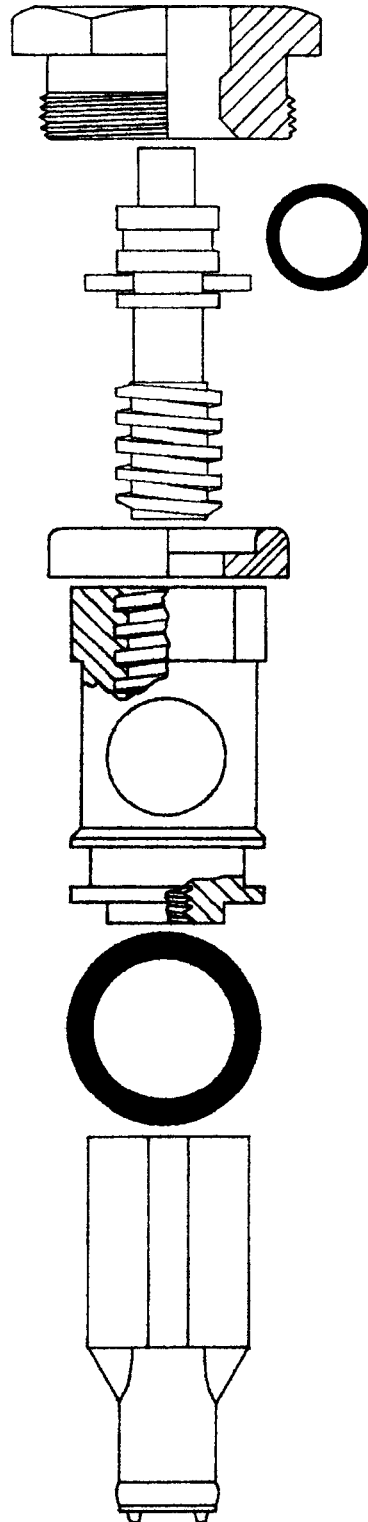

95362
replacement for
Wade #WKO3

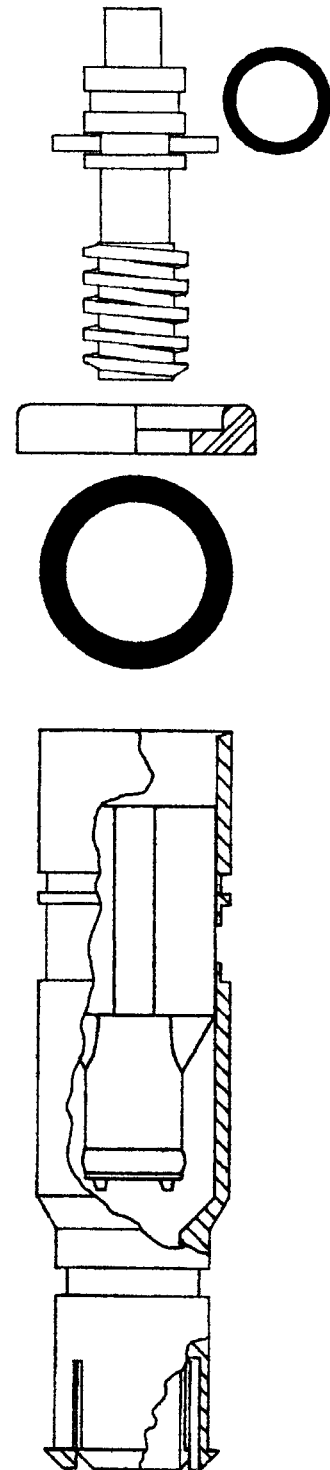

95369
replacement for
Wade #WKO4

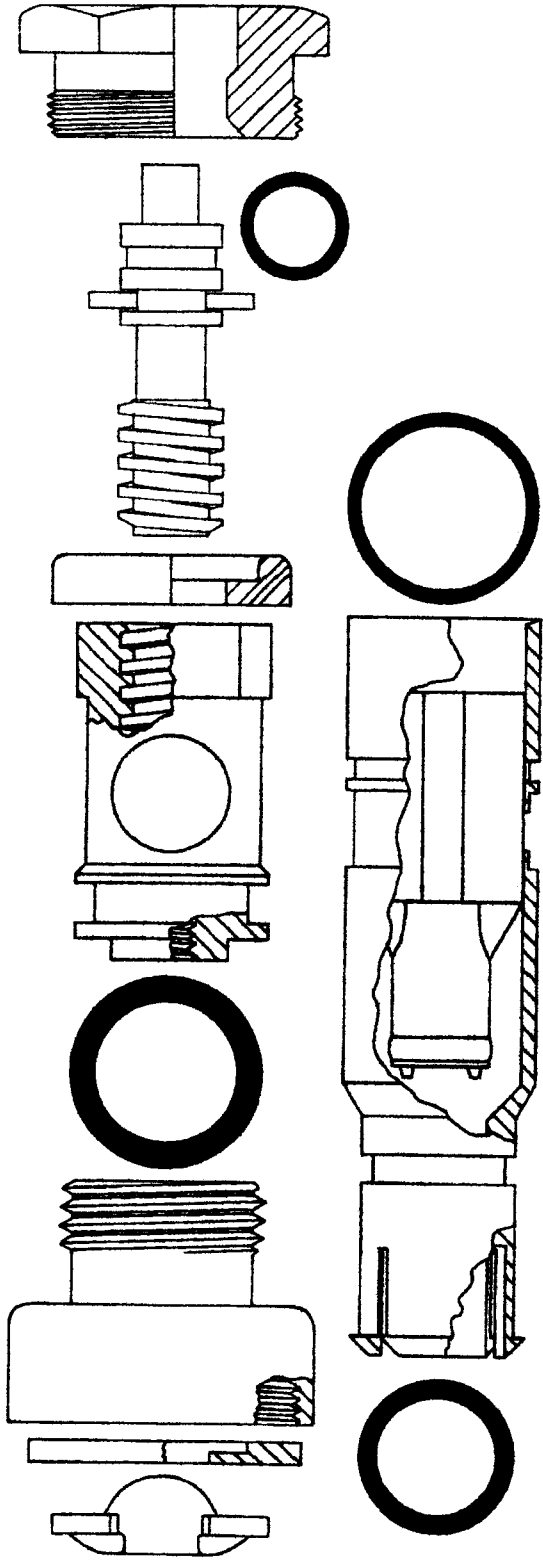

95363
replacement for
Wade #WKO5

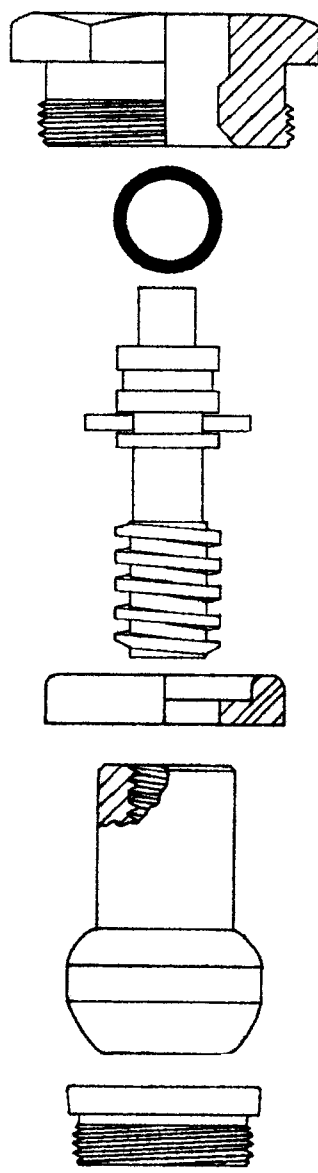

95364
replacement for
Wade #WKO6

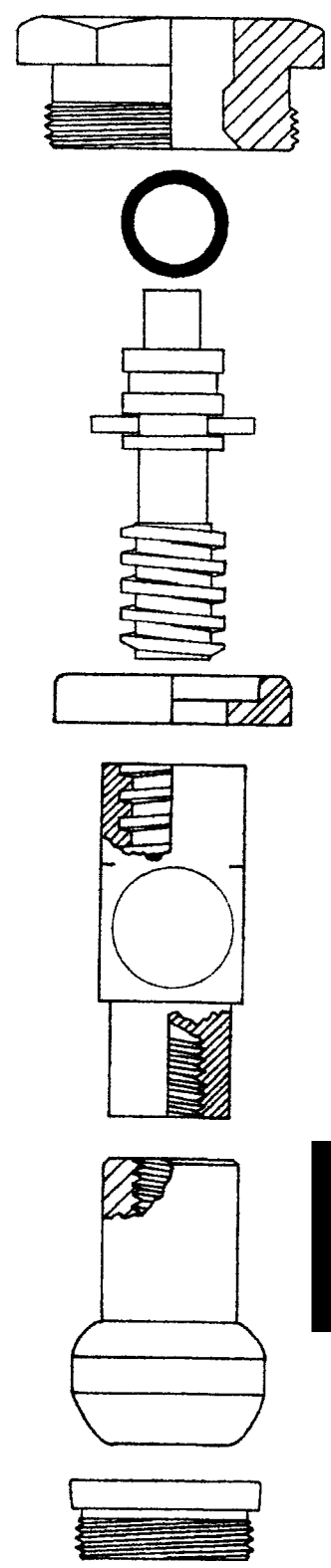

95365
replacement for
Wade #WKO7

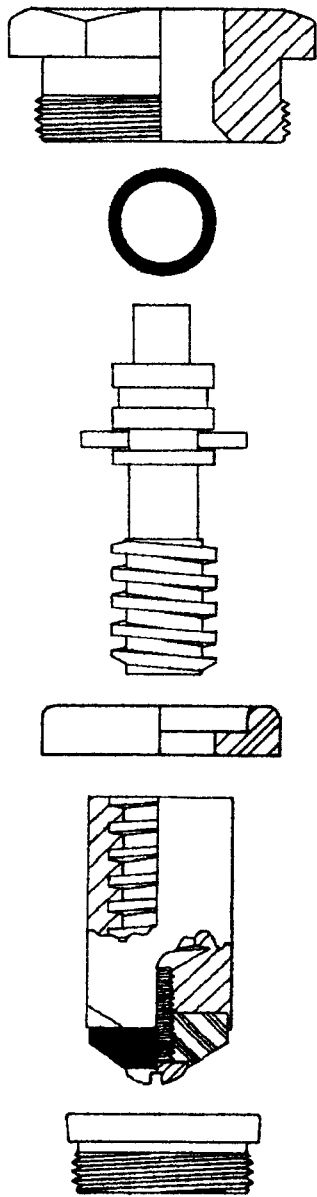

95370
replacement for
Wade #WKO10

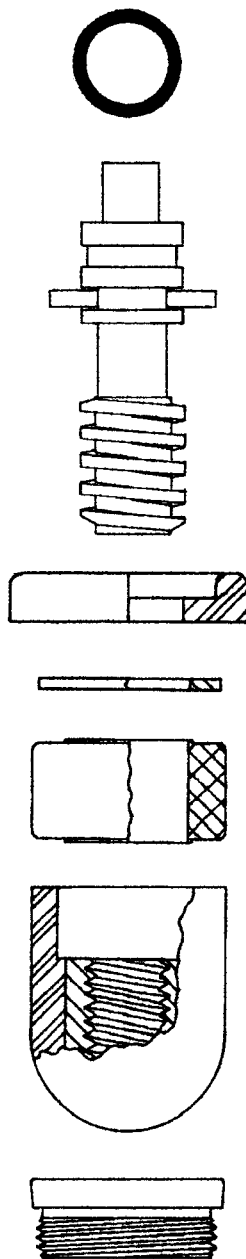

95371
replacement for
Wade #WKO11

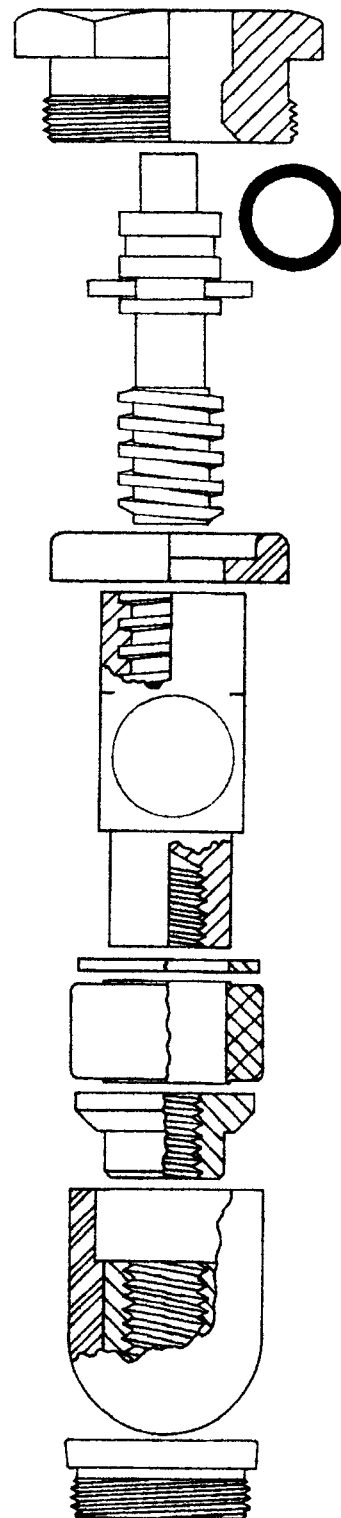

95366
replacement for
Wade #WK12

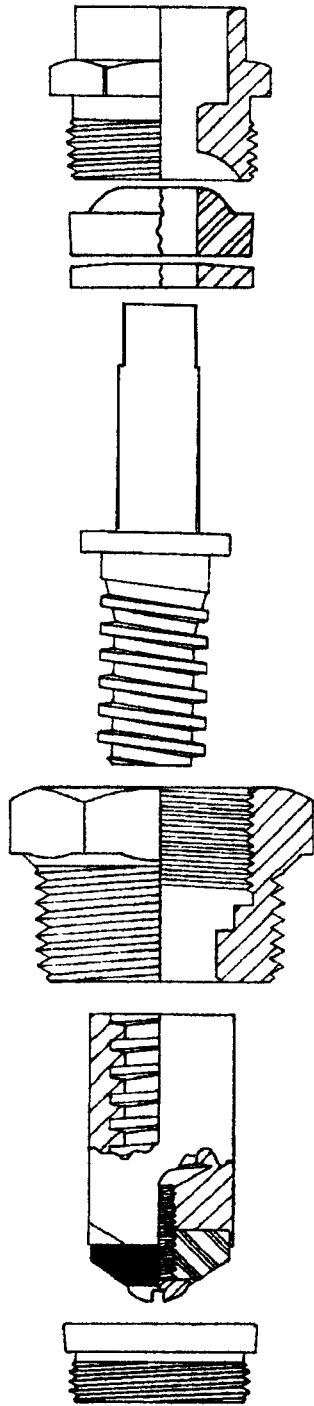

95367
replacement for
Wade #WK14

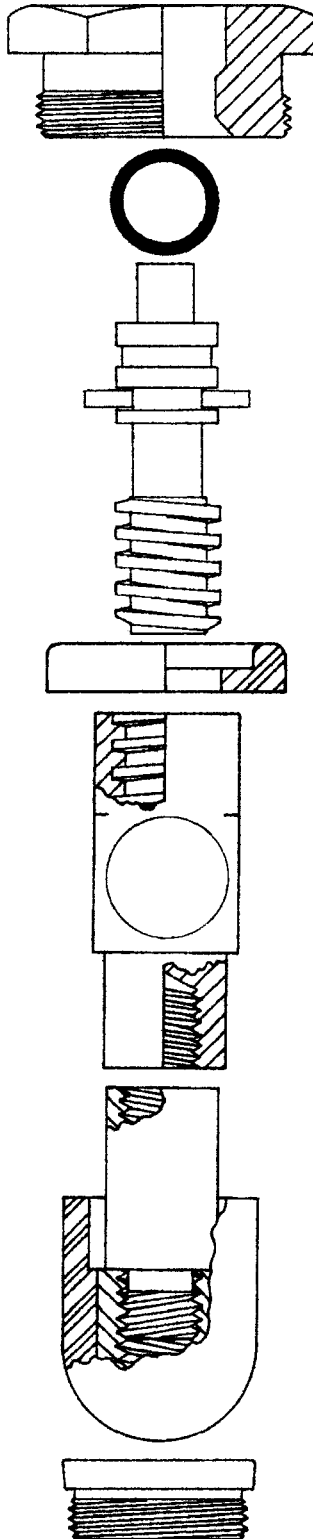

95368
replacement for
Wade #WK17

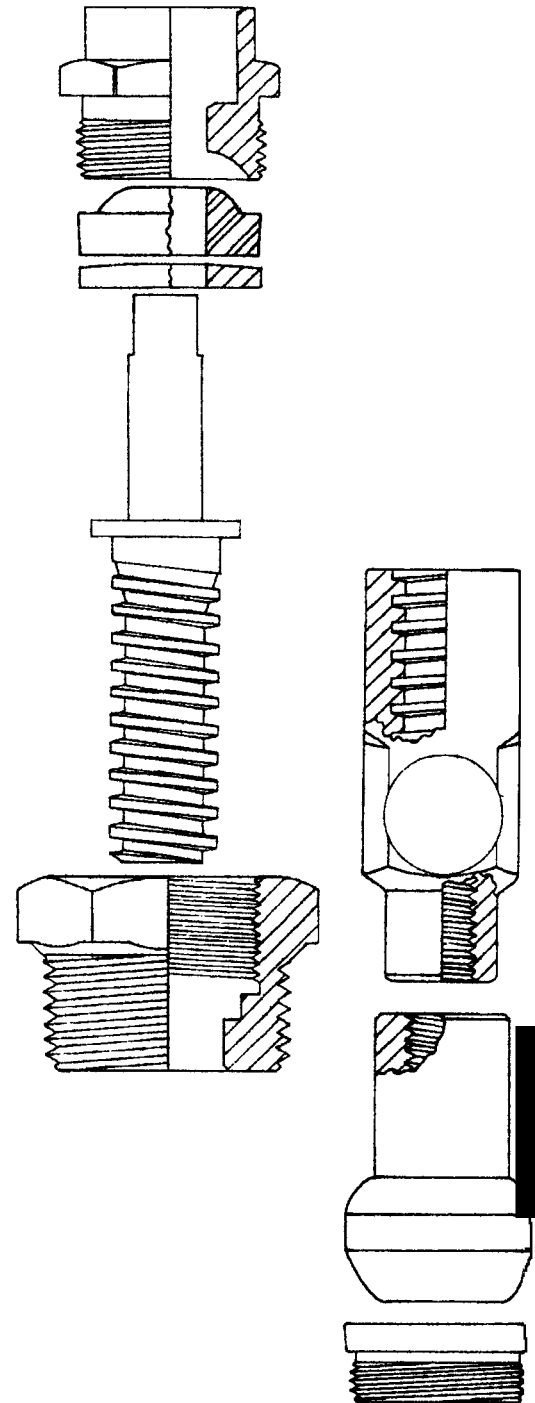

8

95375
replacement for
Woodford #RK-14

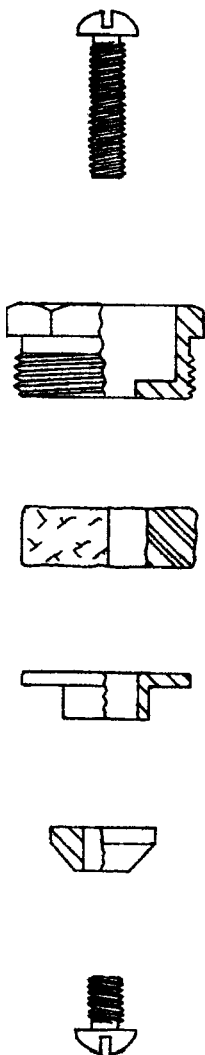

95376
replacement for
Woodford #RK-17

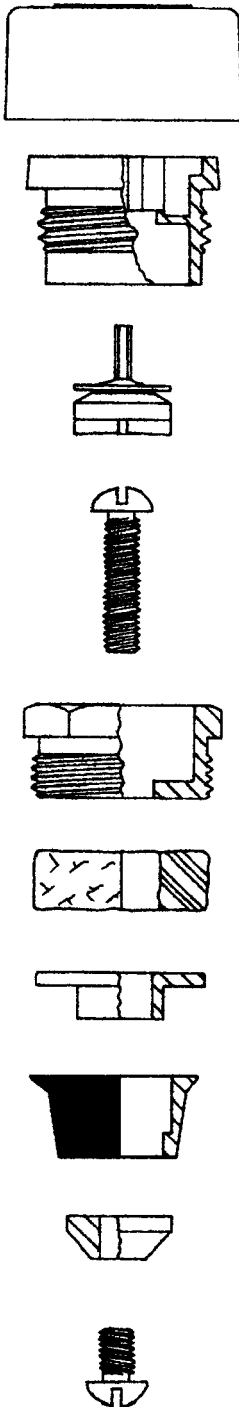

95377
replacement for
Woodford #RK-25

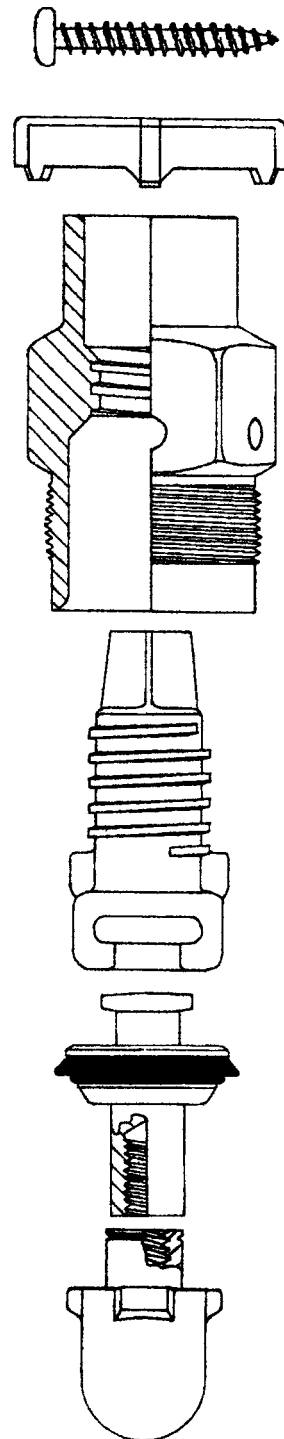

95001
replacement for
Woodford #RK-65

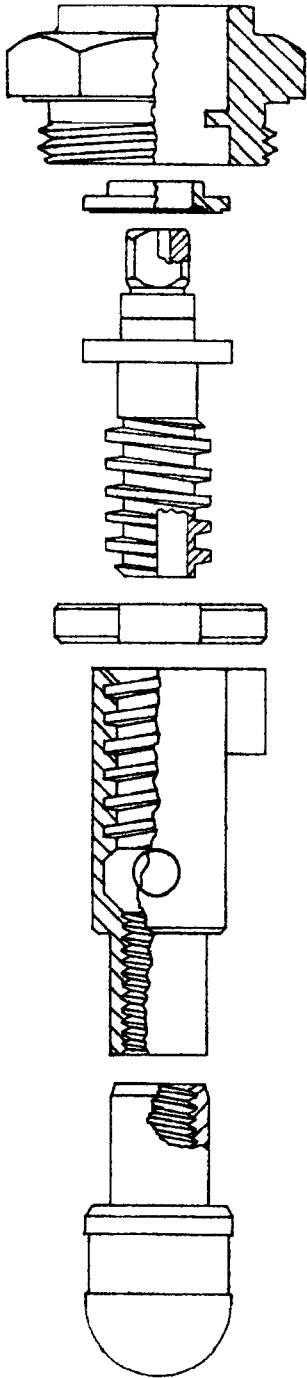

95002
replacement for
Woodford #RK-70

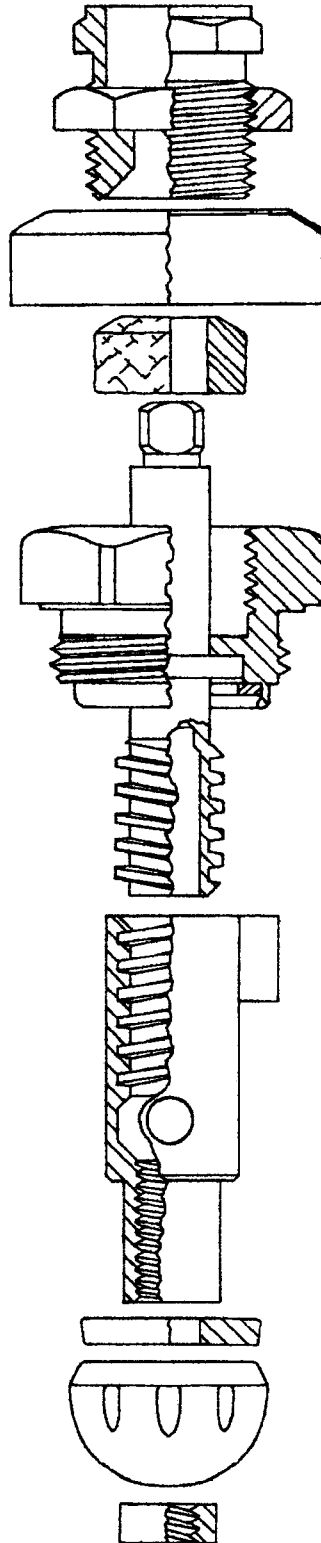

95003
replacement for
Woodford #RK-71

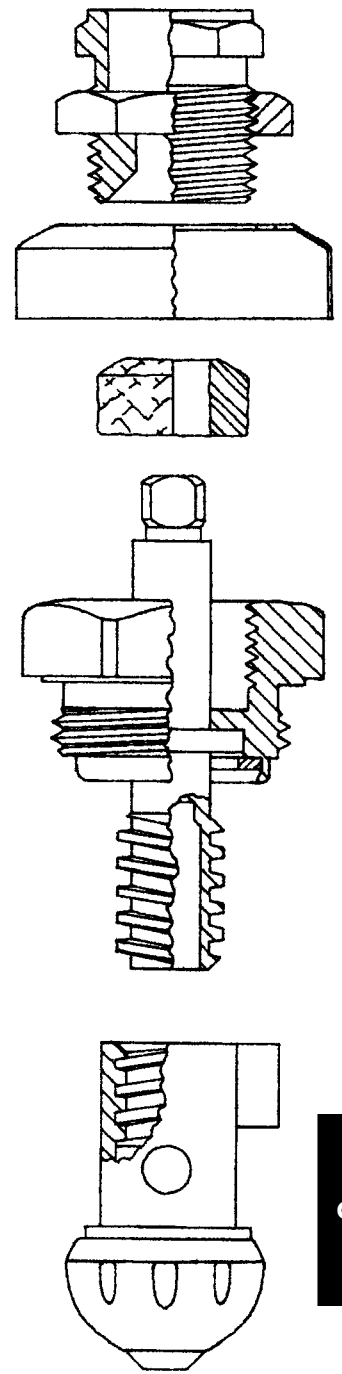

95001
replacement for
Woodford #RK-Y30

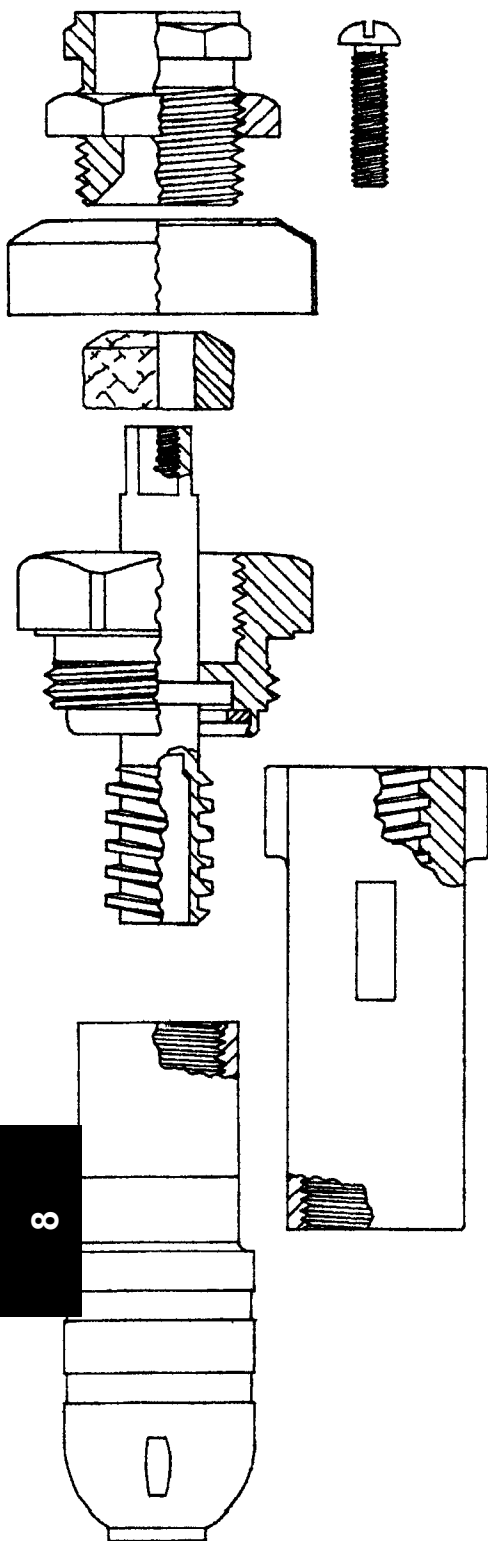

95002
Sreplacement for
Woodford #RK-75

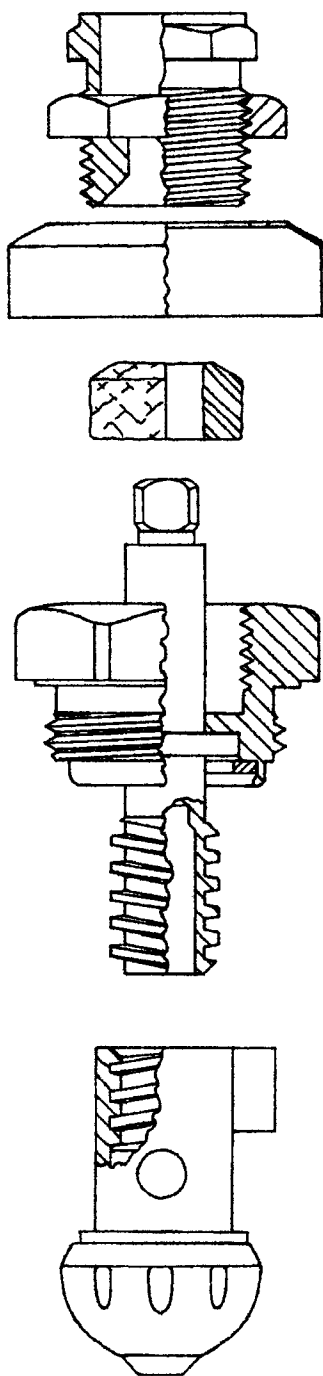

95003
replacement for
Woodford #RK-Y95

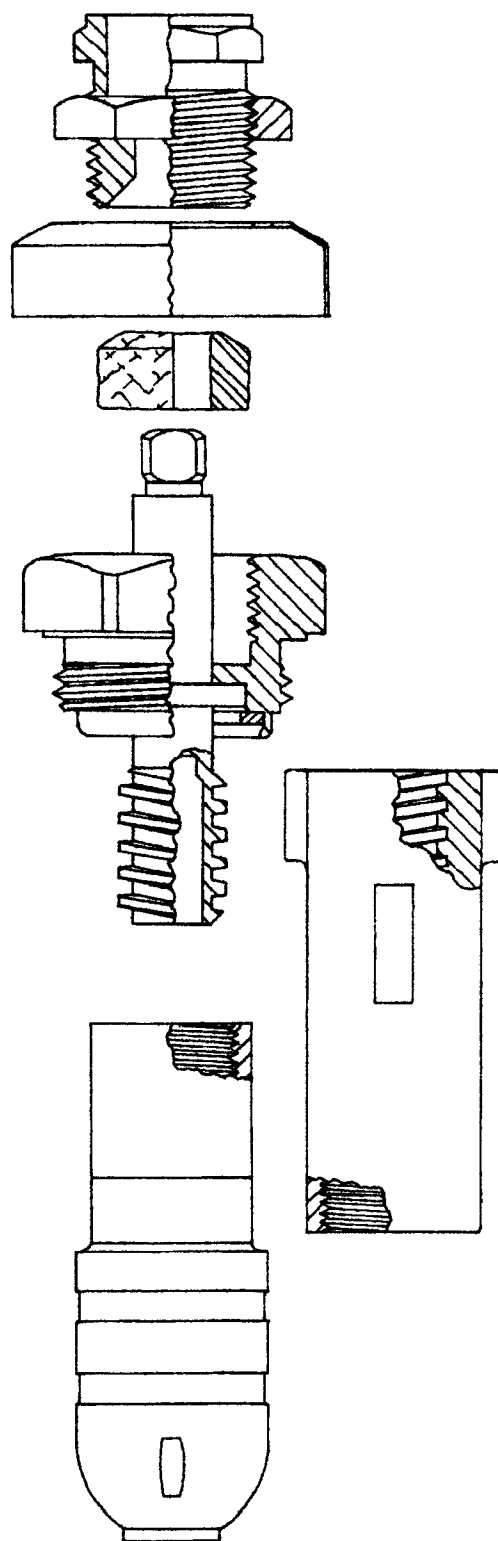

95390
 replacement for
 Zurn Z-1300RK /
 Z-1310RK

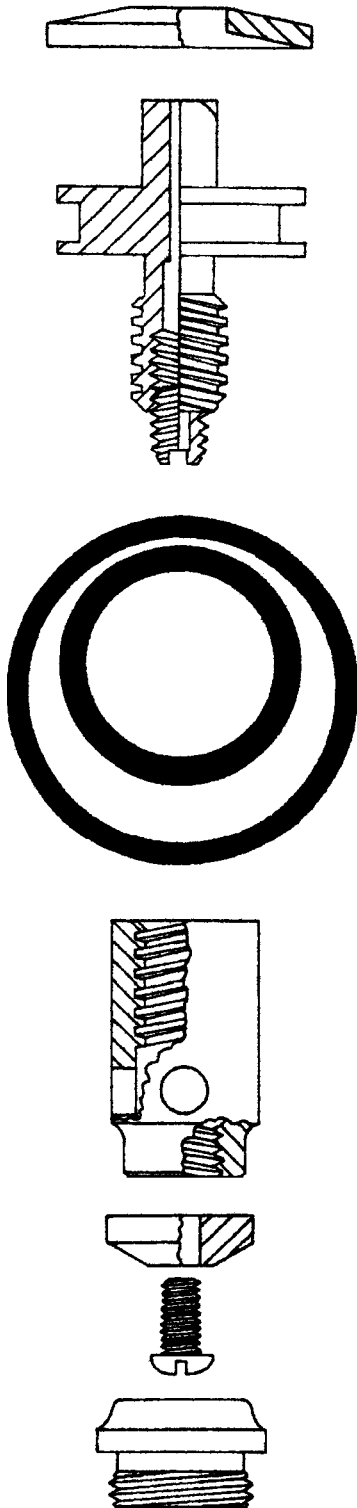

95391
 replacement for
 Zurn Z-1305RK / Z-
 1315RK / Z-1325RK
 (use 2)

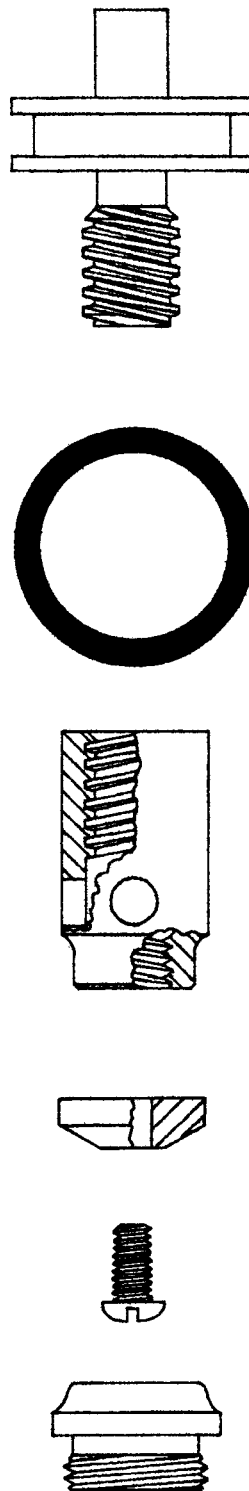

95392
 replacement for
 Zurn Z-1320RK /
 Z-1321RK

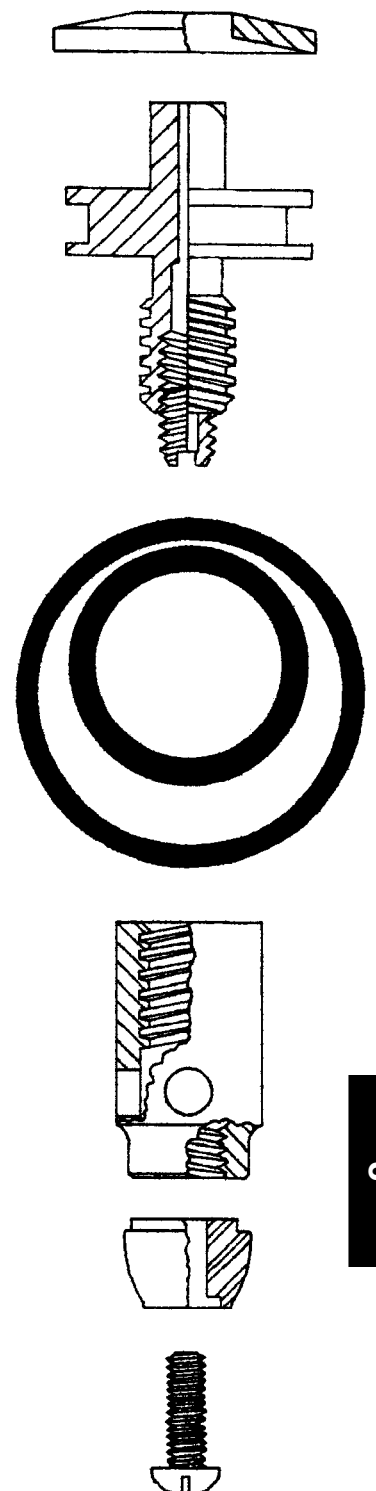

95393
 replacement for
 Zurn Z-1330RK /
 Z-1333RK

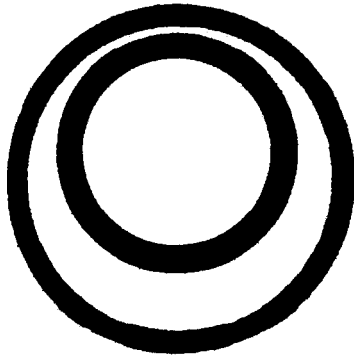
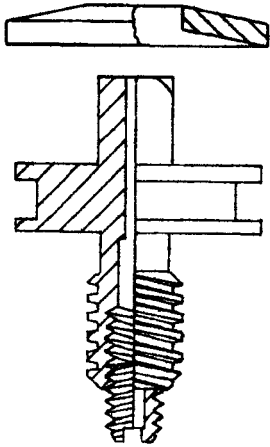

95394
 replacement for
 Zurn Z-1335RK /
 Z-1375RK

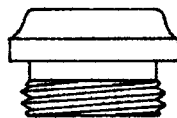
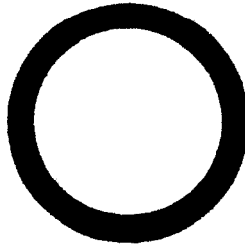
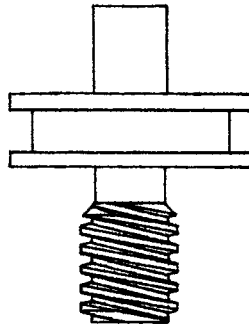

95395
 replacement for
 Zurn Z-1360RK /
 Z-1370RK / Z-1385RK

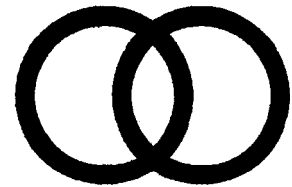
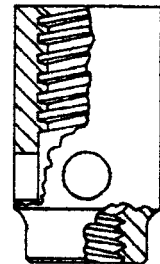
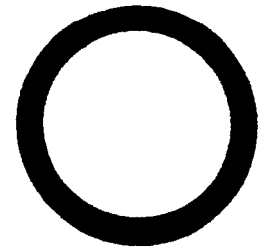
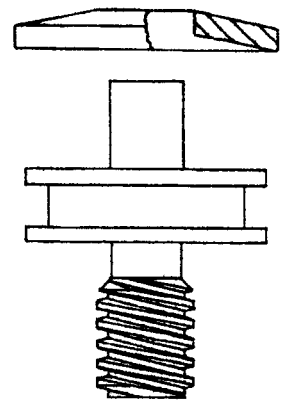

**Series #Y-200 freez-
less wall hydrant**

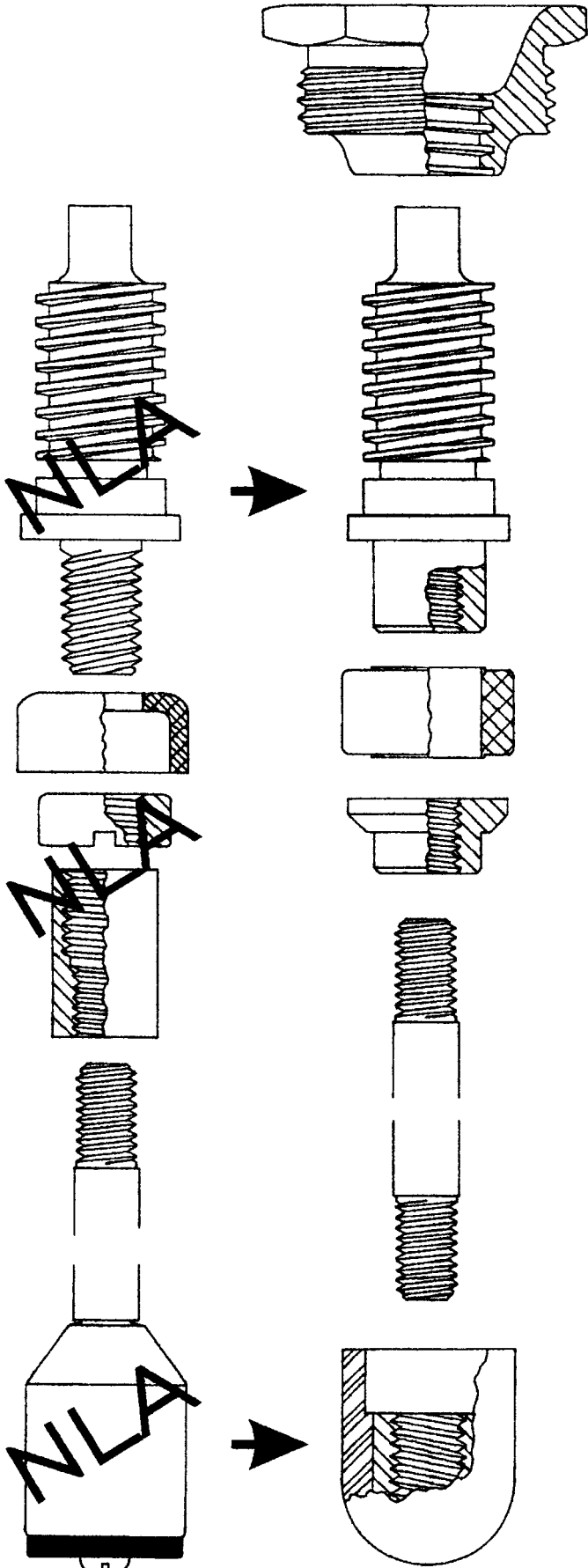

95062
replacement head
nut

95035
replacement
operating stem

95075
3/8" brass rod

95013P
plunger

Series #Y-210
freezeless wall
hydrant

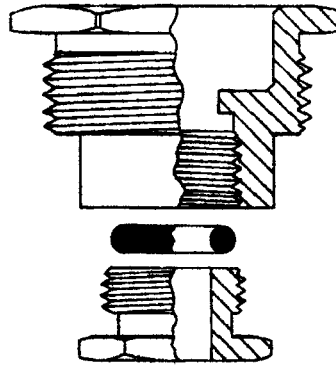

95061
replacement head
nut assembly

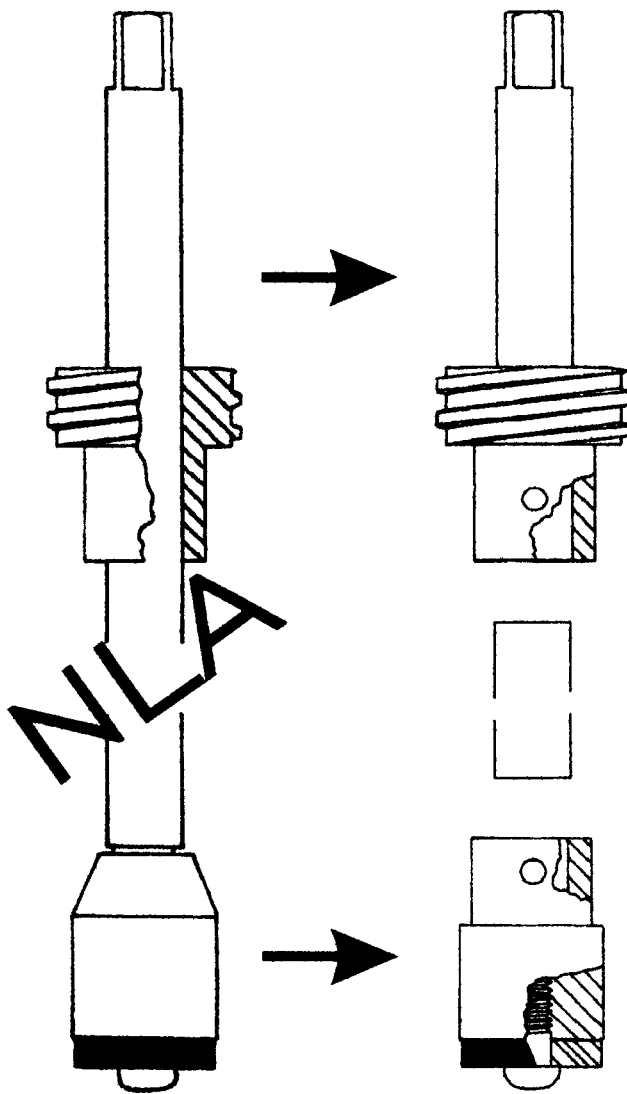

95032
replacement guide
screw

95075
3/8" brass rod

95111
replacement plunger
assembly

95134
stainless steel roll
pin

Hydrasan I Freezeless Wall Hydrant

95106N
Cap retainer



95106B
Draw nut

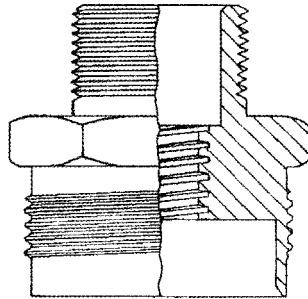

95037
Upper section

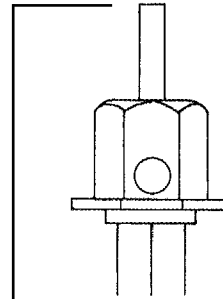

Bottom view

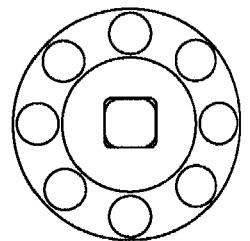

95006
Actuator with o-ring
and set screw

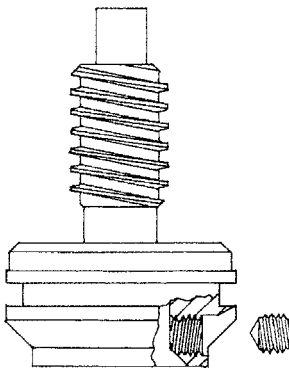

JO.095825
Set screw

JO.101
O-ring

Operating rod

95038
Lower section

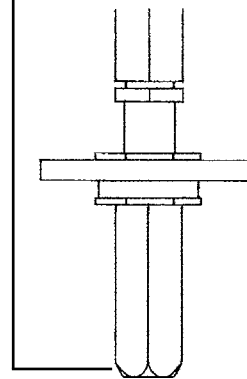

95027

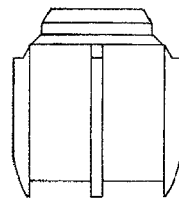
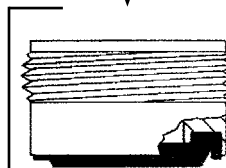

JO.095816B
Warm climate
shuttle

Repair Kit:
95323
Includes: tee key,
actuator, o-ring,
seat/seal, cold
climate shuttle

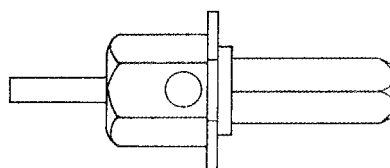

JO.09581S
Warm climate rod

Rod "L" Dimension

- 4-7/8"
- 6-7/8"
- 8-7/8"
- 10-7/8"
- 12-7/8"
- 14-7/8"
- 16-7/8"
- 18-7/8"
- 20-7/8"
- 22-7/8"
- 24-7/8"
- 26-7/8"

*Special order

Hydrasan II Freezeless Wall Hydrant

95106N
Cap retainer



95106B
Draw nut

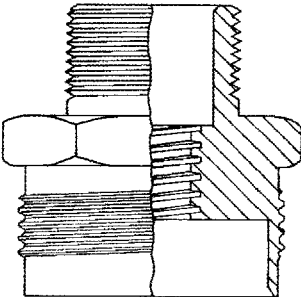

95006
Actuator with o-ring
and set screw

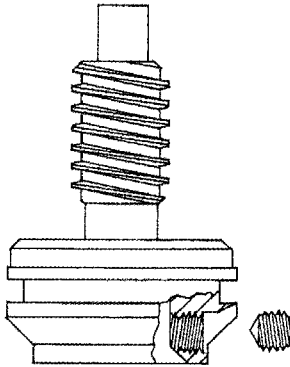

JO.095825
Set screw

JO.101
O-ring

Operating rod

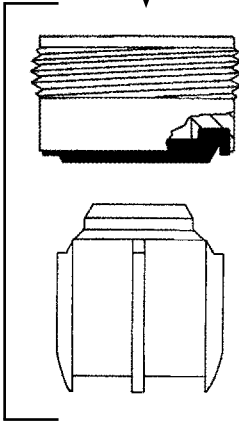

95027

Repair Kit:
95323
Includes: tee key,
actuator, o-ring,
seat/seal, cold
climate shuttle

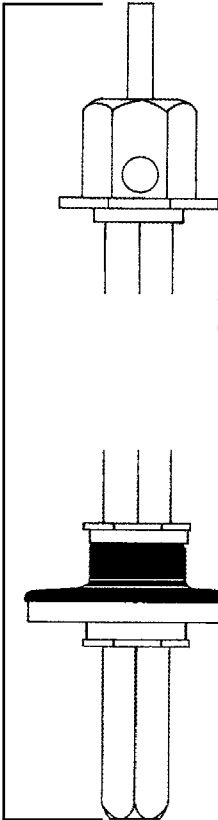

Not available as
separate parts
entire stem must be
replaced

"L"

Rod "L" Dimension

- 4-7/8"
- 6-7/8"
- 8-7/8"
- 10-7/8"
- 12-7/8"
- 14-7/8"
- 16-7/8"
- 18-7/8"
- 20-7/8"
- 22-7/8"
- 24-7/8"
- 26-7/8"

*Special order

94584
Smith face nut

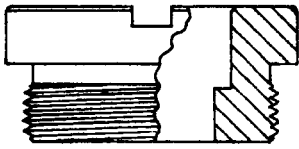

95002
coarse thread
operating screw
11569 o-ring
22015 key

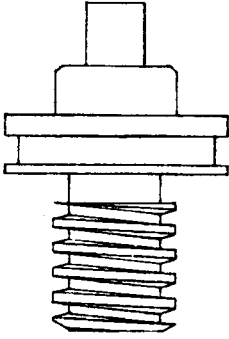

95001
fine thread
operating screw
11569 o-ring
22015 key

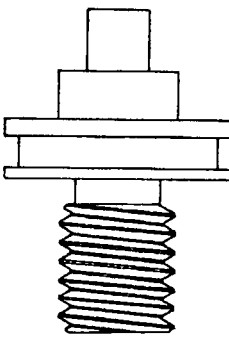

95102
coarse thread
block

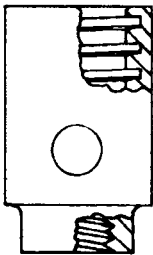

95101
fine thread
block

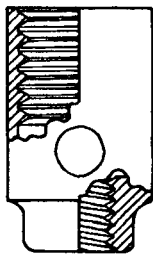

95000
plunger
11011 washer
11031 screw

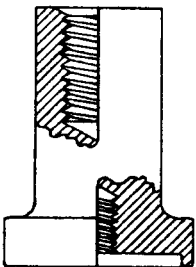

Repair kit:
95341
key
operating screw (coarse)
operating screw o-ring
plunger o-ring
neoprene seat washer
seat washer screw
removable seat

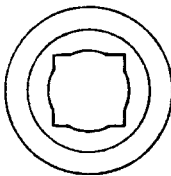
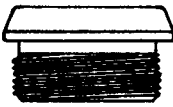

95024
brass seat

Repair kit:
95342
key
operating screw (fine)
operating screw o-ring
neoprene seat washer
seat washer screw
removable seat

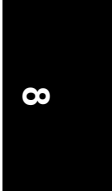

94584
Smith face nut

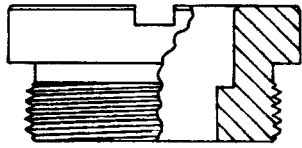

95030
coarse thread
operating screw

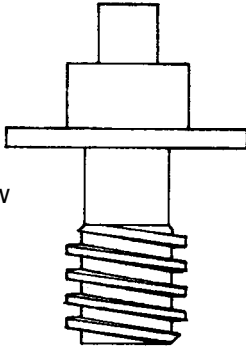

95031
fine thread
operating screw

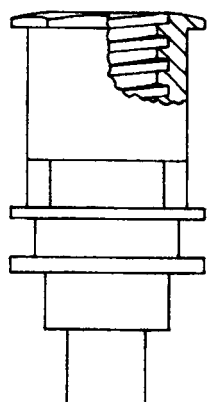
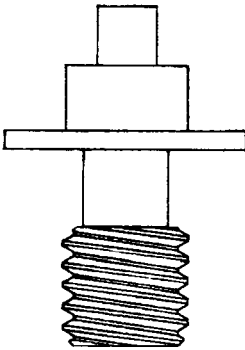

11568
operating coupling
o-ring

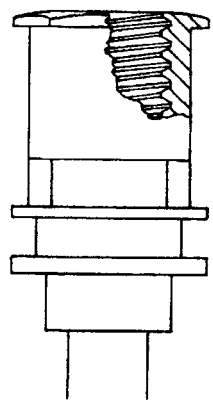

11539
rear o-ring

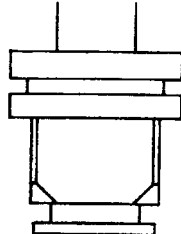

11533
front o-ring

Repair kit:
95340
key
operating screw (coarse)
operating coupling o-ring
plunger o-ring rear
plunger o-ring front
removable brass seat

Repair kit:
95340
operating screw (fine)
operating coupling o-ring
plunger o-ring rear
plunger o-ring front
removable brass seat

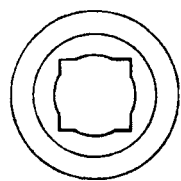
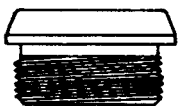

95024
brass seat

94584
Smith face nut

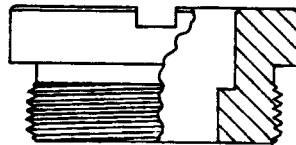

95002
coarse thread
operating screw
11569 o-ring
22015 key

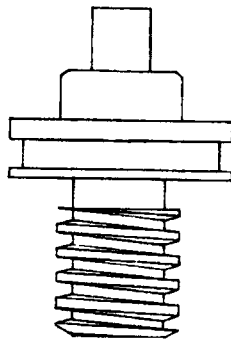

95001
fine thread
operating screw
11569 o-ring
22015 key

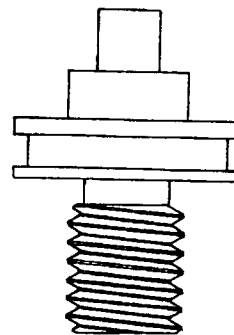

95102
coarse thread
block

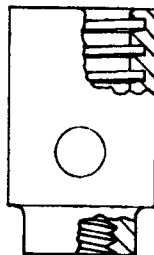

95101
fine thread
block

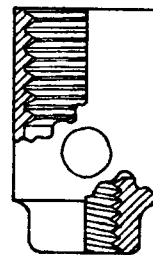

11569
rear o-ring

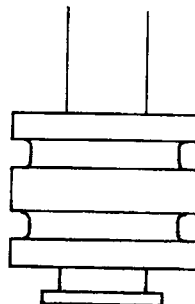

11569
rear o-ring

11533
front o-ring

Repair kit:
95344
key
operating screw (coarse)
operating screw o-ring
plunger o-rings rear
plunger o-ring front
neoprene washer
washer screw
removable seat



95024
brass seat

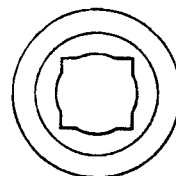

Repair kit:
95345
key
operating screw (fine)
operating screw o-ring
plunger o-rings rear
plunger o-ring front
neoprene washer
washer screw
removable seat

94584
Smith face nut

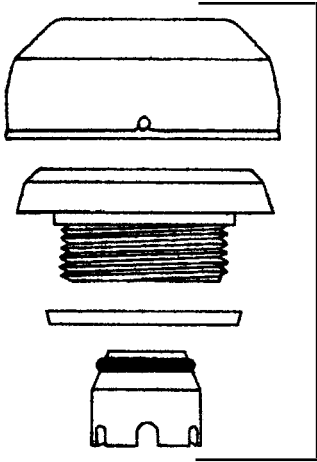
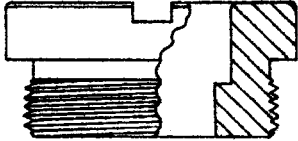

94405
vacuum breaker
repair kit

95002
coarse thread
operating screw
11569 o-ring
22015 key

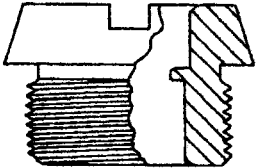
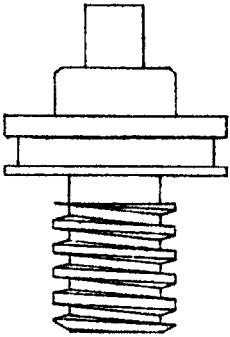

94586
PN 74400-72-6
face nut

94587
coupling plunger
11533 o-ring

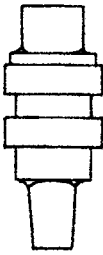
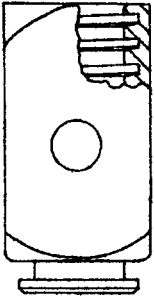

94588
operator
11532 o-ring
22015 key

95024
brass seat

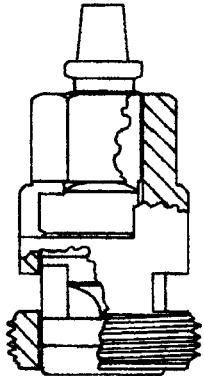
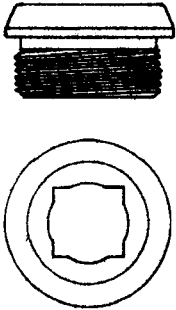

94589
valve body assy.
retaining ring
valve body
valve actuator
nylon thrust washer
rotating ceramic disc
fixed ceramic disc
silicon rubber seal
retainer guide

Repair kit:
94590
key
operating screw (coarse)
operating screw o-ring
coupling / plunger
plunger o-ring
removable brass seat

Repair kit:
94591
key
operator
operator o-ring
face nut washer
valve body assy.
11/16 - 3/8 drive socket



**Series #378
frost proof style**

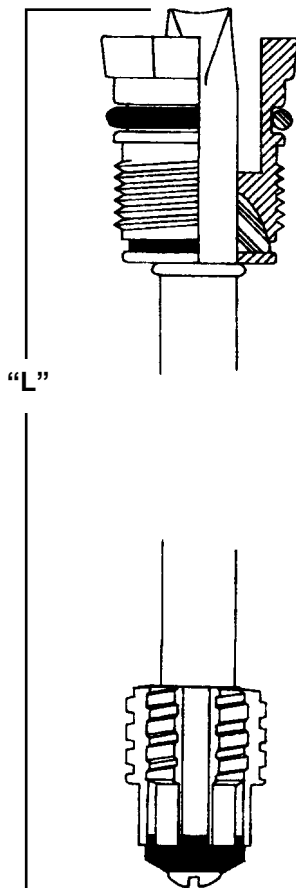

94410
handle (not pictured)

94411
handle screw (not pictured)

94412
stem packing (not pictured)

11016
seat washer

11030
seat washer screw

**Repair kit:
94418**
bonnet
bonnet o-ring
stem packing
packing washer
seat washer
seat washer screw

stem "L" diminsion

| "L" | Cat# | Description |
|--------|-------|-------------|
| 7-1/2 | 94418 | 4" model |
| 9-1/2 | 94413 | 6" model |
| 11-1/2 | 94414 | 8" model |
| 13-1/2 | 94415 | 10" model |
| 15-1/2 | 94416 | 12" model |
| 17-1/2 | 94417 | 14" model |

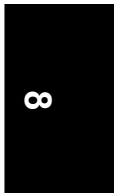

Series #578 anti-siphon frost-proof style

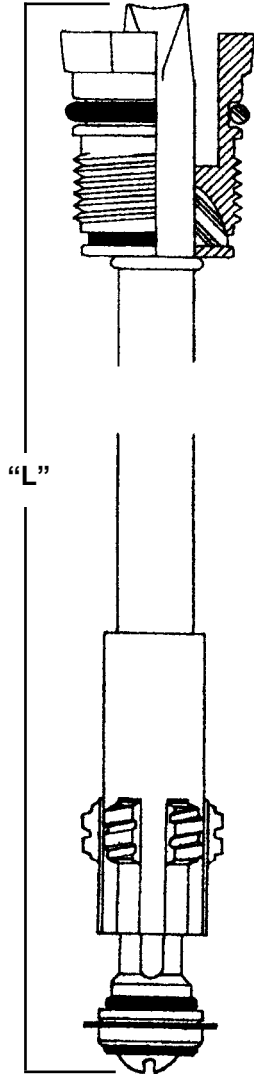

94420
handle (not pictured)

94421
handle screw (not pictured)

94422
stem packing (not pictured)

94423
stainless steel spring

94424
o-ring

94425
retainer & bibb
washer assembly

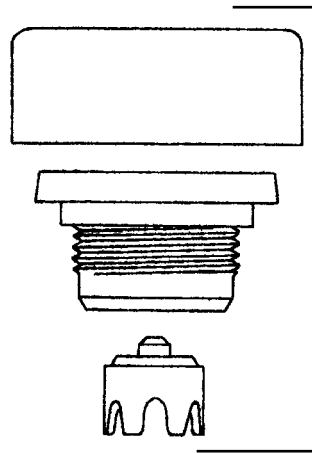

94426
vacuum breaker
repair kit

Repair kit:

94427
o-ring
bonnet
bonnet o-ring
backflow washer
packing washer
bibb retainer
seat washer
seat washer screw

stem "L" dimension

| "L" | Cat# | Description |
|--------|-------|-------------|
| 9-1/2 | 94428 | 6" model |
| 11-1/2 | 94429 | 8" model |
| 13-1/2 | 94430 | 10" model |
| 15-1/2 | 94431 | 12" model |
| 17-1/2 | 94432 | 14" model |

**Series #80 & 80-VB
frost-proof sillcocks**

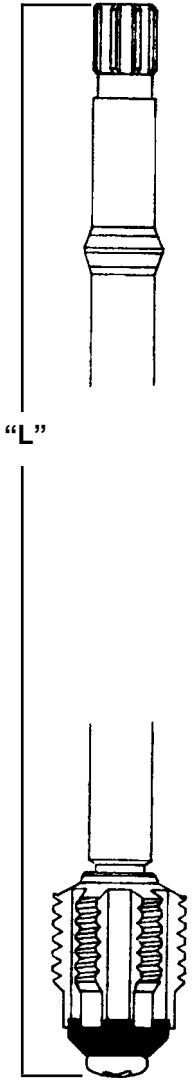

94433
plastic tulip handwheel
(not pictured)

94434
handle screw (not pictured)

94435
bonnet nut (not pictured)

94436
stem packing (not pictured)

94437
packing washer (not pictured)

11016
seat washer

11030
seat washer screw

stem "L" dimension

| "L" | Cat# | Description |
|--------|-------|-------------|
| 6-3/8 | 94438 | 4" model |
| 8-3/8 | 94439 | 6" model |
| 10-3/8 | 94440 | 8" model |
| 12-3/8 | 94441 | 10" model |
| 14-3/8 | 94442 | 12" model |
| 16-3/8 | 94443 | 14" model |

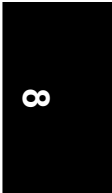

**Series #90
frost-proof sillcock**

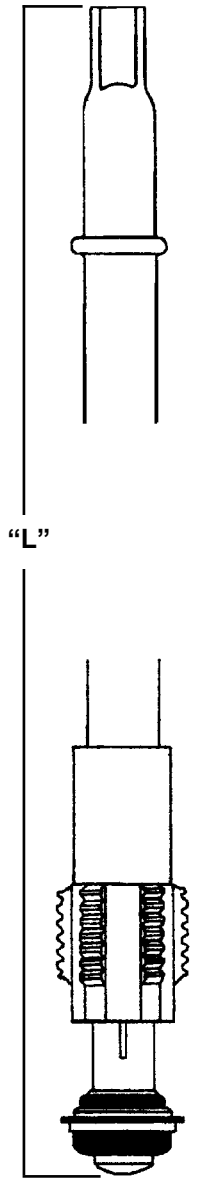

94444
aluminum handwheel
(not pictured)

94445
handwheel screw
(not pictured)

94446
stuffing nut (not pictured)

94447
stem packing (not pictured)

94448
packing washer (not pictured)

94449
seat spring (not pictured)

94450
seat assembly

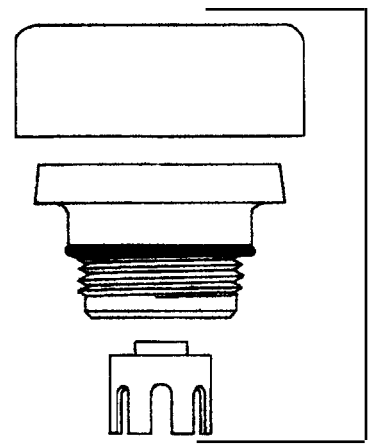

94451
vacuum breaker
repair kit

stem "L" diminsion

| "L" | Cat# | Description |
|--------|-------|-------------|
| 6-1/2 | 94452 | 4" model |
| 8-1/2 | 94453 | 6" model |
| 10-1/2 | 94454 | 8" model |
| 12 1/2 | 94455 | 10" model |
| 14-1/2 | 94456 | 12" model |
| 16-1/2 | 94457 | 14" model |

MODEL HAS BEEN DISCONTINUED

**Series #52
frost-proof sillcock**

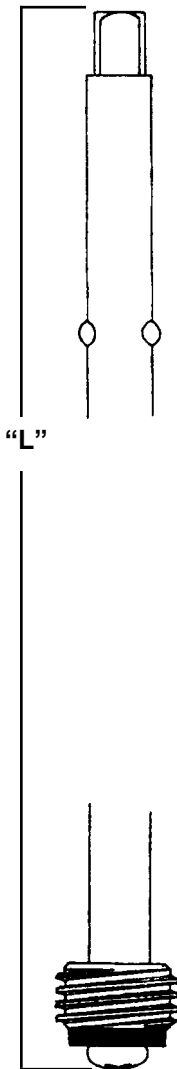

94458
plastic tulip handwheel
(not pictured)

94459
handle screw (not pictured)

94460
bonnet nut (not pictured)

94461
stem packing (not pictured)

94462
packing washer (not pictured)

11001
seat washer

11030
seat washer screw

stem "L" diminsion

| "L" | Cat# | Description |
|-----|-------|-------------|
| 6 | 94463 | 4" model |
| 8 | 94464 | 6" model |
| 10 | 94465 | 8" model |
| 12 | 94466 | 10" model |
| 14 | 94467 | 12" model |
| 16 | 94468 | 14" model |



**Series #FH-1 / FH-1-MI
Series #FH-2 / FH-2-MI
frost-proof sillcock**

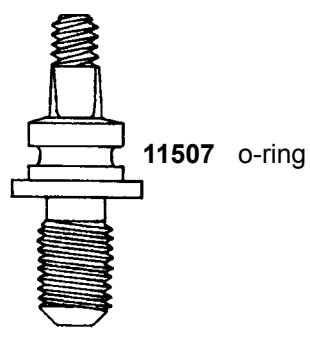

**Repair kit:
94469
FH-MI-HK
handle
handle nut**

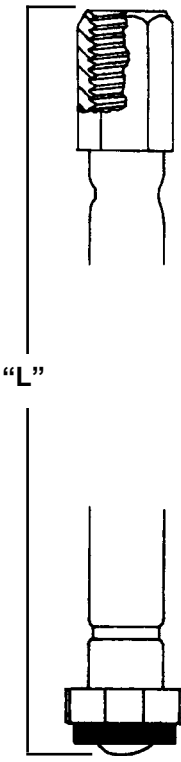

stem "L" diminsion

| "L" | Cat# | Description |
|-----|-------|-------------|
| 6 | 94470 | 4" model |
| 8 | 94471 | 6" model |
| 10 | 94472 | 8" model |
| 12 | 94473 | 10" model |
| 14 | 94474 | 12" model |
| 16 | 94475 | 14" model |

**11001 seat washer
11029 screw**

*manufacturer recommends
replacing entire unit



**Series #FHB-1, FHB-2
anti-siphon frost-proof sillcock**

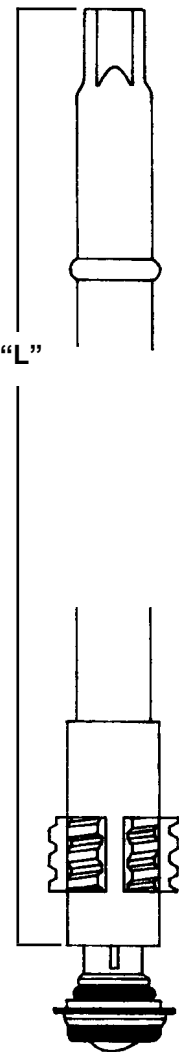

**Repair kit:
94475
RK-FHB-CK**
check sub-assembly
check spring
stem packing

**Repair kit:
94476
FHB-HK**
handle
handle screw

stem "L" diminsion

| "L" | Cat# | Description |
|-----|-------|-------------|
| 7 | 94477 | 4" model |
| 9 | 94478 | 6" model |
| 11 | 94479 | 8" model |
| 13 | 94480 | 10" model |
| 15 | 94481 | 12" model |
| 17 | 94482 | 14" model |

*manufacturer recommends
replacing entire unit



MODEL HAS BEEN DISCONTINUED

**Series #FHV-1, FHV-2 new style
anti-siphon frost-proof
automatic draining wall hydrant**

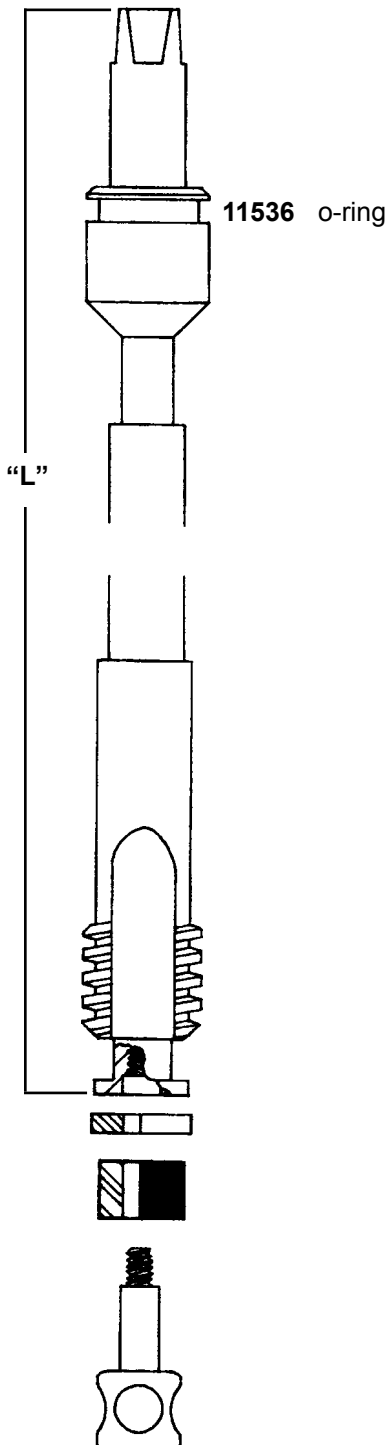

Repair kit:
94490
FHV-HK
 handle
 handle screw
22015 key

stem "L" dimension

| "L" | Cat# | Description |
|---------|-------|-------------|
| 7-1/16 | 94491 | 4" model |
| 9-1/16 | 94492 | 6" model |
| 11-1/16 | 94493 | 8" model |
| 13-1/16 | 94494 | 10" model |
| 15-1/16 | 94495 | 12" model |
| 17-1/16 | 94496 | 14" model |

MODEL HAS BEEN DISCONTINUED

**Series #FHV-1, FHV-2 old style
anti-siphon frost-proof
automatic draining wall hydrant**

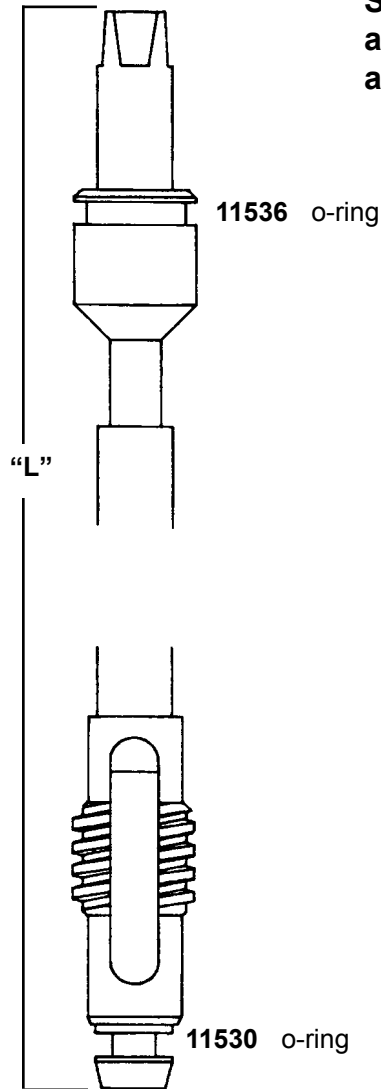

11536
large o-ring (top)

11530
small o-ring (bottom)

Repair kit:
94483
FHV-HK
handle
handle screw
22015 key

stem "L" diminsion

| "L" | Cat# | Description |
|--------|-------|-------------|
| 7-1/2 | 94484 | 4" model |
| 9-1/2 | 94485 | 6" model |
| 11-1/2 | 94486 | 8" model |
| 13-1/2 | 94487 | 10" model |
| 15-1/2 | 94488 | 12" model |
| 17-1/2 | 94489 | 14" model |



**Series HY-400 & HY-700
wall hydrants prior to July 31, 1988**

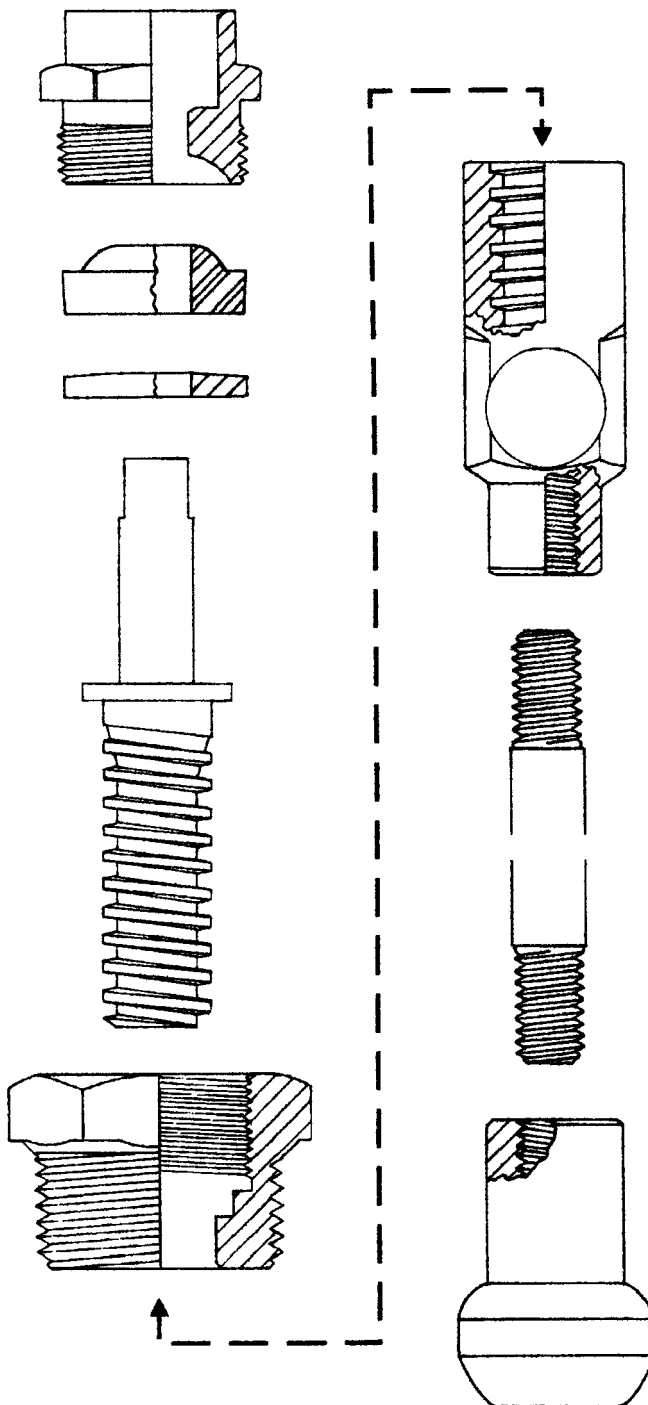

22015
operating key (not pictured)

95057
packing nut

95131
packing ring

95125
brass washer

95007
worm stem

95050
head nut

95108
worm sleeve

95075
brass rod 1"

95012
neoprene plunger

**Series HY-420 / HY-725 / HY-400 / HY-700
wall hydrants August 1, 1988**

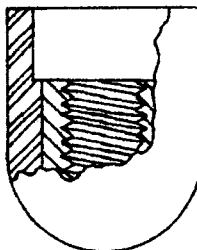
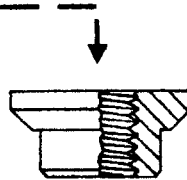
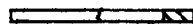
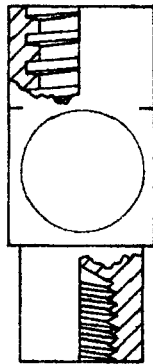
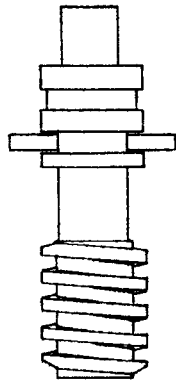
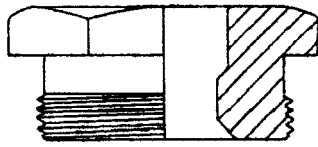

22015
operating key (not pictured)

95053
head nut

95004
worm stem assembly

95126
nylon washer

95110
worm sleeve

95129
brass washer

95127
packing seal

95135
retaining bushing

95075
brass rod 1"

95013P
neoprene plunger

**SeriesW-8600
frost-free wall hydrant**

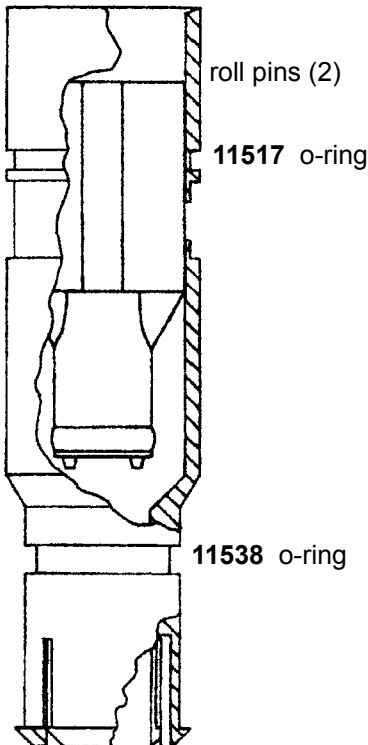
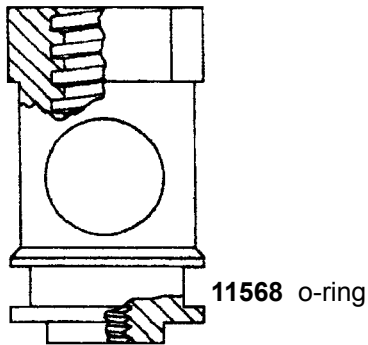
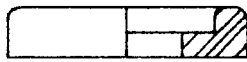
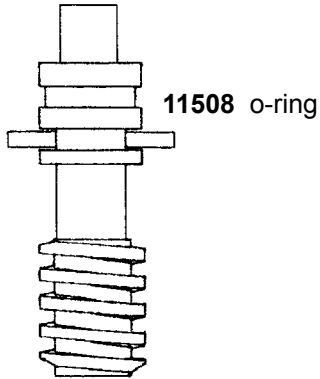
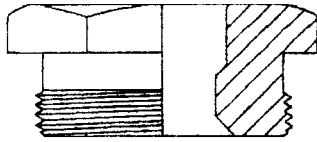

95053
face nut

95004
drive screw assy.

95126
retainer

95112
drive sleeve

11568
drive sleeve o-ring

95022
plunger
95023 with sleeve

Repair kit:
95360
replacement for WK01
drive screw assy.
retainer seal
drive sleeve o-ring
plunger
tee key

Repair kit:
95361
replacement for WK02
face nut
drive screw assy.
retainer seal
drive sleeve
drive sleeve o-ring
plunger
tee key

Repair kit:
95362
replacement for WK03
drive screw assy.
retainer seal
drive sleeve o-ring
cartridge plunger assy.
tee key

Repair kit:
95369
replacement for WK04
face nut
drive screw assy.
retainer seal
drive sleeve
drive sleeve o-ring
cartridge plunger assy.
hose piece
diverter diaphragm
diverter check spider
tee key

**Series 8609 & 8610 (1" & 1-1/4")
ground box & post hydrants**

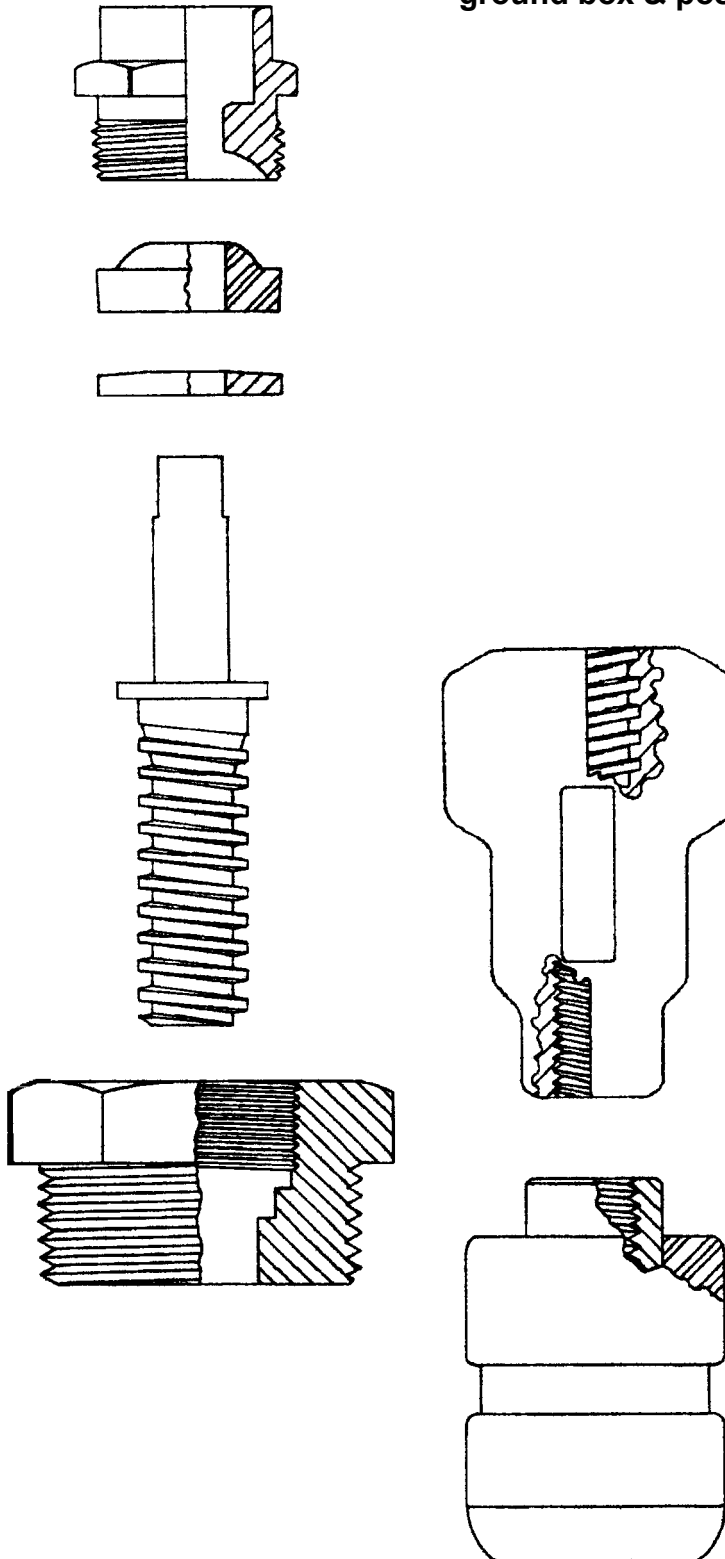

95057
packing nut

95131
packing

95125
packing washer

95007
worm stem

95052
worm nut

95104
worm sleeve

95018
plunger

Repair kit:

95372
packing nut
packing
packing washer
worm stem
worm sleeve
plunger
tee key

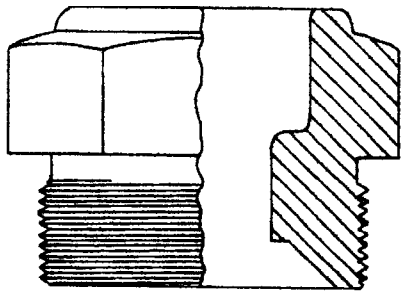

**Series 8609 & 8610 (1-1/2" & 2")
ground box & post hydrants**

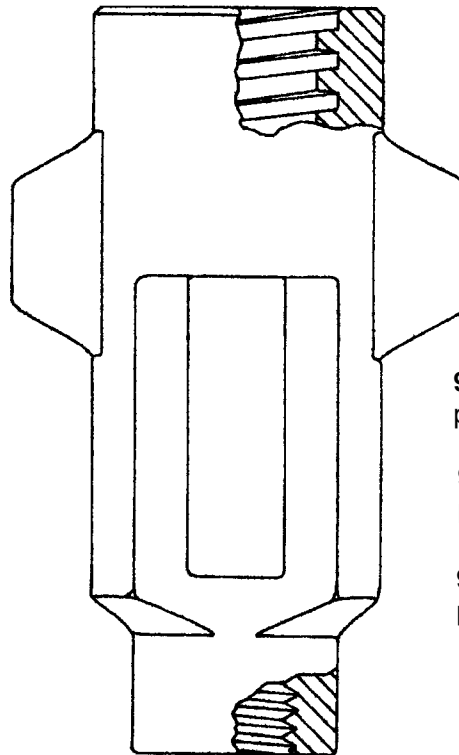
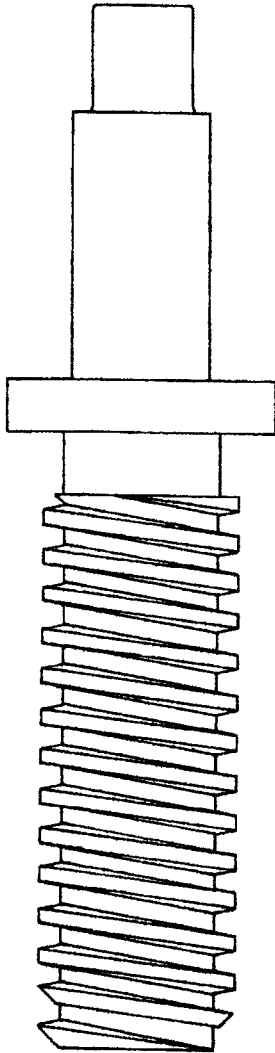

- 95055**
packing nut
- 95128**
packing (not pictured)
- 95130**
packing washer (not pictured)
- 95101**
worm stem
- 95056**
worm nut
- 95105**
worm sleeve
- 95019**
plunger

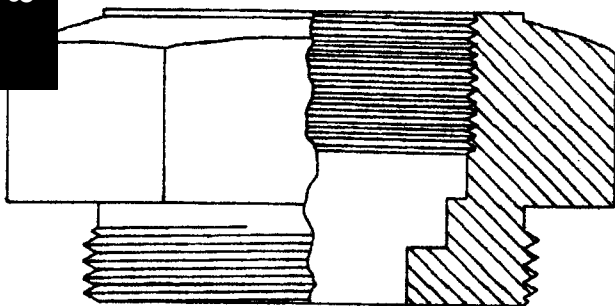

Series 14 & 15 freezeless wall faucet

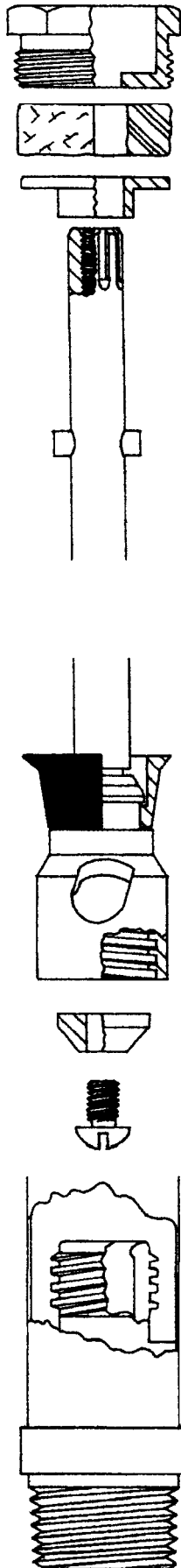

**Repair kit:
94490**
vacuum breaker float
plastic handle (not pict.)
handle screw
packing nut
packing
packing support washer
check valve
valve seat wrench
retainer screw

**Repair kit:
94491**
plastic handle (not pict.)
handle screw
packing nut
packing
packing support washer
valve seat wrench
retainer screw

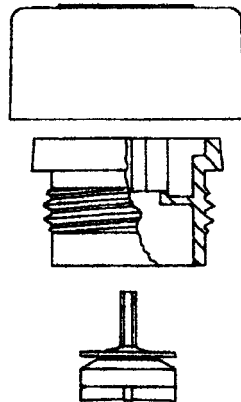

94492
handle (not pictured)

94493
handle screw (not pictured)

94494
stem packing (not pictured)

94495
check valve

94496
seat washer

94497
seat washer screw

**Repair kit:
94489**
vacuum breaker repair kit
(included in RK-17 kit)

stem "L" dimension

| "L" | Cat# | Description |
|--------|-------|-------------|
| 5-7/8 | 94498 | 4" model |
| 7-7/8 | 94499 | 6" model |
| 9-7/8 | 94500 | 8" model |
| 11-7/8 | 94501 | 10" model |
| 13-7/8 | 94502 | 12" model |
| 15-7/8 | 94503 | 14" model |
| 17-7/8 | 94504 | 16" model |
| 19-7/8 | 94505 | 18" model |
| 25-7/8 | 94506 | 24" model |

Series 20, 25, 27 automatic draining freezeless wall faucets

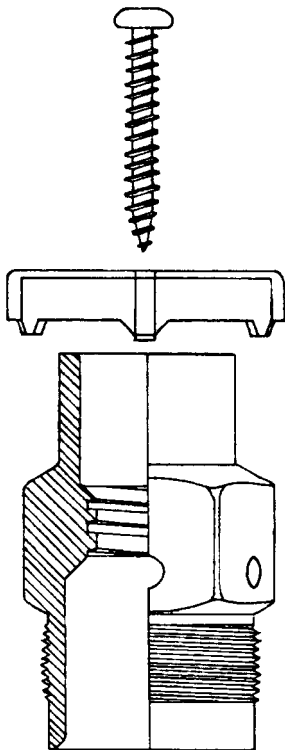

- Repair kit:**
94507
 metal handle (not pictured)
 handle screw
 drain guard
 brass head nut
 stem screw
 drain valve assembly
 plunger assembly

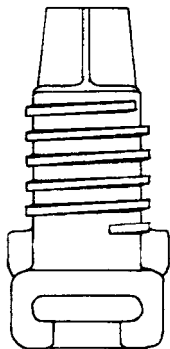

94508
 handle (not pictured)

94511
 head nut, brass

94509
 handle screw (not pictured)

94512
 stem screw

94510
 drain guard

94513
 drain valve assembly

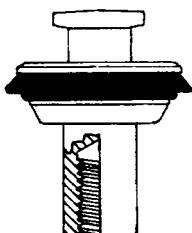

95015
 plunger assembly

stem "L" dimension, wall thickness + 7/16"

| "L" | Cat# | Description |
|---------|-------|-------------|
| 4-7/16 | 94514 | 4" model |
| 6-7/16 | 94515 | 6" model |
| 8-7/16 | 94516 | 8" model |
| 10-7/16 | 94517 | 10" model |
| 12-7/16 | 94518 | 12" model |
| 14-7/16 | 94519 | 14" model |
| 18-7/16 | 94520 | 18" model |
| 24-7/16 | 94521 | 24" model |

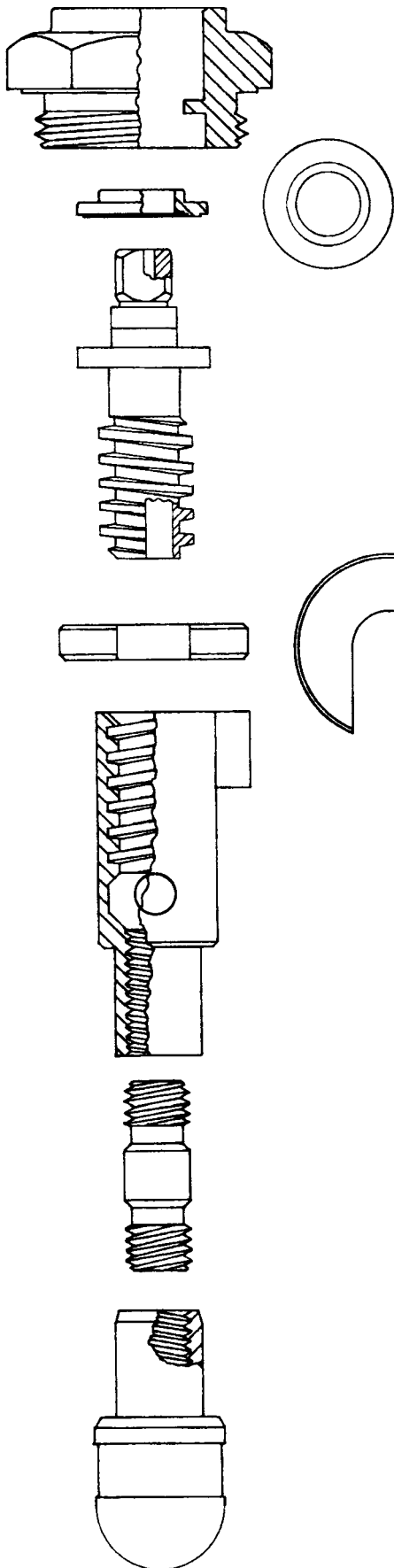

**Series 60, 65, 60B, 65B
automatic draining
freezeless wall hydrants**

**Repair kit:
94522**

- tee key (not pictured)
- head nut
- stem washer
- stem screw
- "C" washer
- yoke nut
- plunger

94523
head nut, chrome

94524
stem washer

94525
stem screw

94526
"C" washer

94527
yoke nut

95016
plunger

stem "L" dimension

| "L" | Cat# | Description |
|--------|-------|-------------|
| 3-1/2 | 94528 | CC wall |
| 6-1/2 | 94529 | 4" wall |
| 8-1/2 | 94530 | 6" wall |
| 10-1/2 | 94531 | 8" wall |
| 12-1/2 | 94532 | 10" wall |
| 14-1/2 | 94533 | 12" wall |
| 16-1/2 | 94534 | 14" wall |
| 18-1/2 | 94535 | 18" wall |
| 26-1/2 | 94536 | 24" wall |



Series 71, 71B, 74, 75, 75B, 81, 84 close coupled wall hydrants

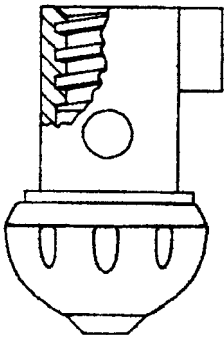
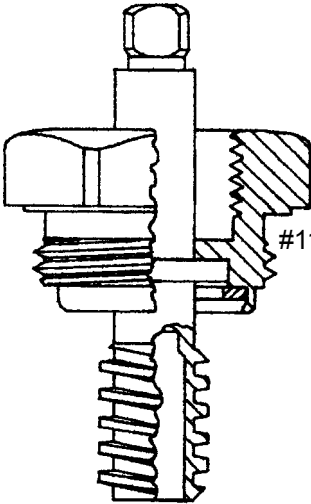
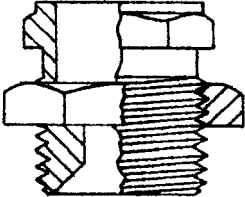

Repair kit:

- 94552**
tee key (not pictured)
- packing nut assembly
- packing
- head nut cover
- head nut assembly
- yoke nut
- valve assembly

- 22015**
tee key (not pictured)

- 94554**
packing nut assy. chrome

- 94555**
head nut cover, chrome

- 94556**
packing

- 94557**
head nut assembly

- 94558**
yoke nut & valve assy.
"plunger"

- 95017**
ball valve rubber



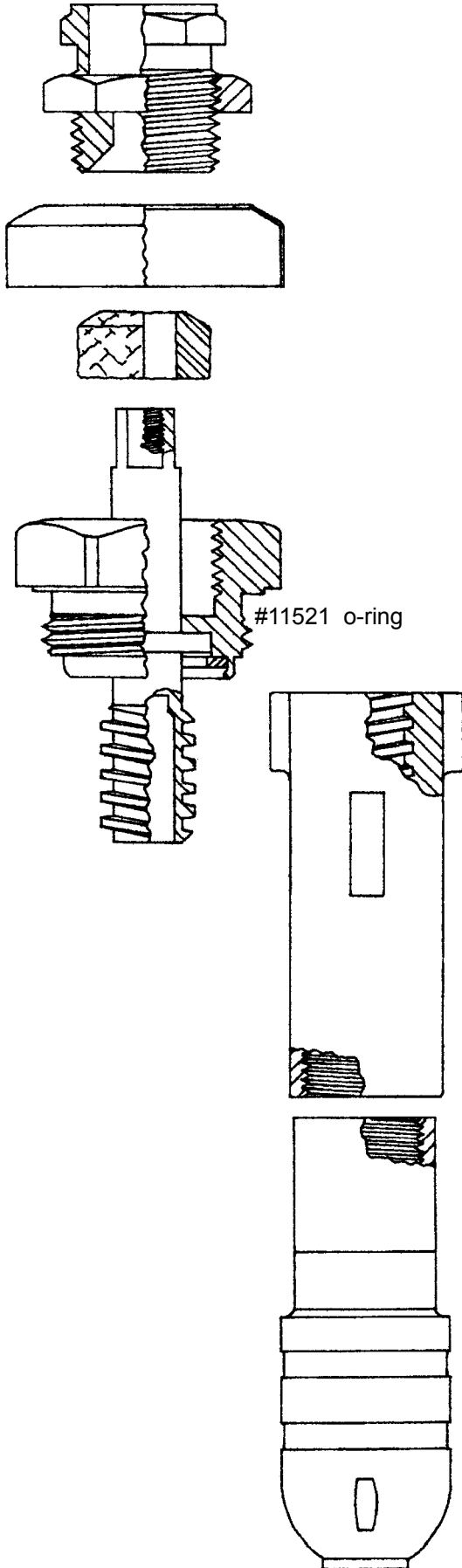

Series Y30 freezeless yard hydrant post model

Repair kit:

94559

handle screw (not pictured)
wheel handle (not pictured)
packing nut assembly
packing
head nut cover
head nut assembly
yoke nut
plunger

94560

handle screw (not pictured)

94561

wheel handle (not pictured)

94562

packing nut assy. brass

94563

head nut cover, brass

94564

packing

94565

head nut assembly

94566

yoke nut

95014

plunger

Series Y70, Y95, freezeless yard hydrants lawn model

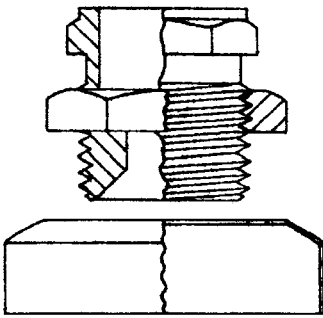

- Repair kit:**
94567
long tee key (not pictured)
packing nut assembly
packing
head nut cover
head nut assembly
yoke nut
plunger

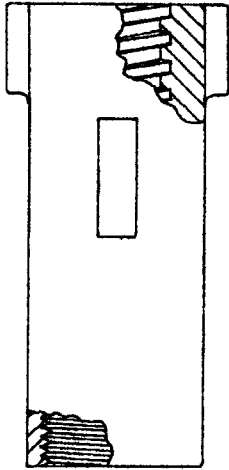
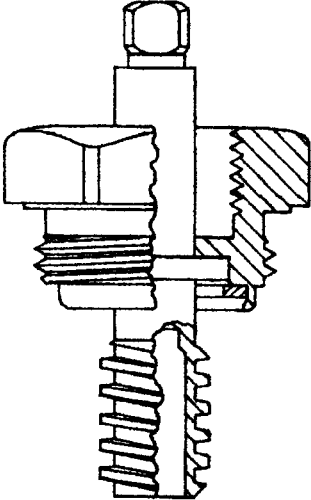
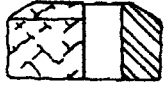

- 94568**
long tee key (not pictured)
- 94569**
packing nut assy. brass

- 94570**
head nut cover, brass

- 94571**
packing

- 94572**
head nut assembly

- 94573**
yoke nut

- 95014**
plunger

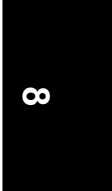
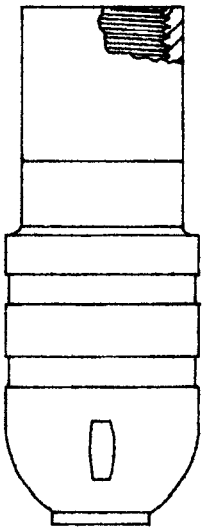

Series Z-1305, Z-1310 freezeless wall hydrants

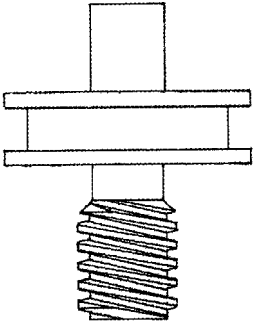

95003
operating screw

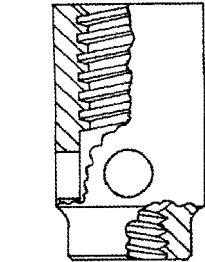

95103
operating coupling

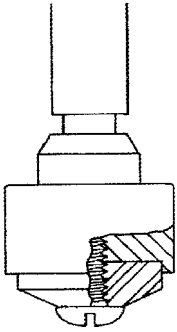

94859
seat washer
94860
seat screw

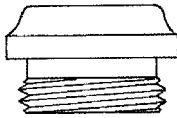

95025
seat

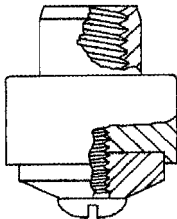

95116
Replacement plunger, will not work as a retrofit, entire lower rod must be replaced

94855
ceramic disc



94856
o-ring



94854
equa balance seal

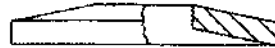

94857
hose nozzle

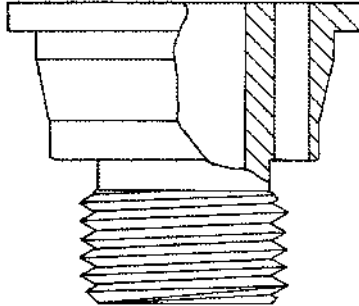

Repair kit:
95391

Includes: operator o-ring, vacuum breaker o-ring, self draining operating screw, operating coupling, equa-balance seal, key, plunger, plunger screw

Repair Kit:
95394

Less operating coupling

Repair Kit:
95399

Includes 95116, 95391 and 24" universal rod (100506)

**Series Z-1320, Z-1321
freezeless Ecolotrol wall hydrants**

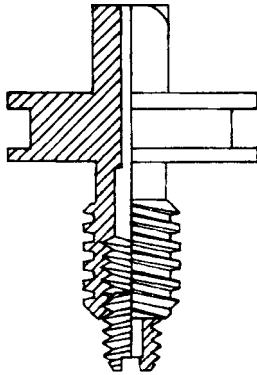

95003A
combination operating screw & relief port
11572 o-ring
22016 key

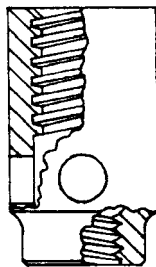

95103
operating coupling

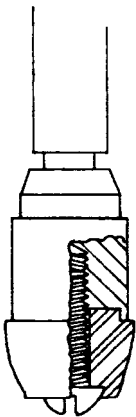

94576
plunger & screw

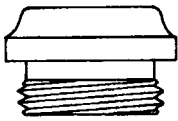

95025 seat

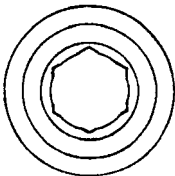

94854
Equa-balance seal for
vacuum breaker
(not to size)

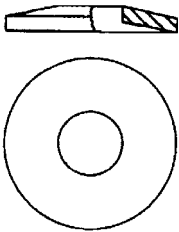

95117
Replacement plunger
will not work as a retrofit
entire lower rod must be
replaced

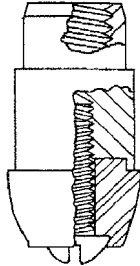

**Repair kit:
94392**
Includes: operator o-ring,
vacuum breaker o-ring,
self draining operating screw,
operating coupling, equa-
balance seal, key, plunger
plunger screw

**Repair Kit:
95400**
Includes 95117, 94392 and
24" universal rod (100506)

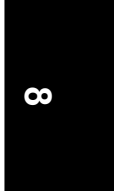

**New style series Z-1320NS, Z-1321NS
freezeless, anti-siphon, automatic draining
Ecolotrol wall hydrants**

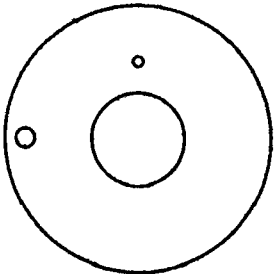
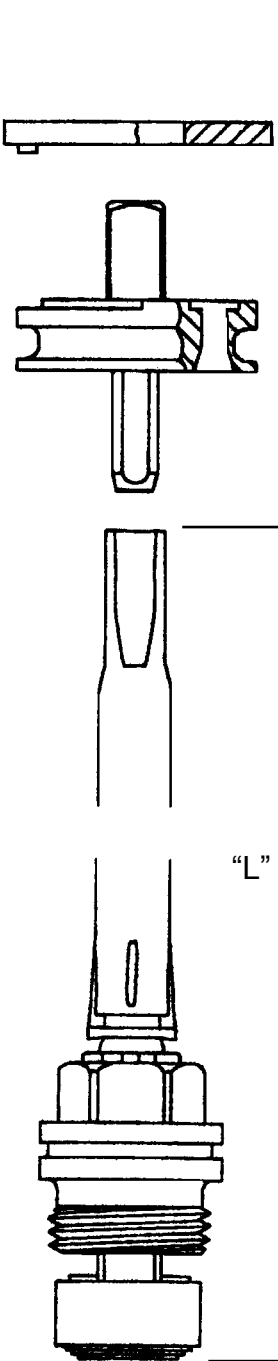

94578
metal retaining washer

94579
drain port o-ring

94580
operator o-ring

94581
operator

94582
operating tube



94583
ceramic disc cartridge,
need overall length:

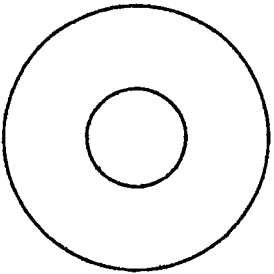

| | | |
|----------------|----------|----------|
| Actual/Overall | 1320 | 1321 |
| | Box | |
| 8-1/8" | 8" wall | |
| 10-1/8" | 10" wall | 8" wall |
| 12-1/8" | 12" wall | 10" wall |
| 14-1/8" | 14" wall | 12" wall |

94854
Equa-balance seal

Repair kit:
94594
operating screw
o-rings
equa-balance seal
key



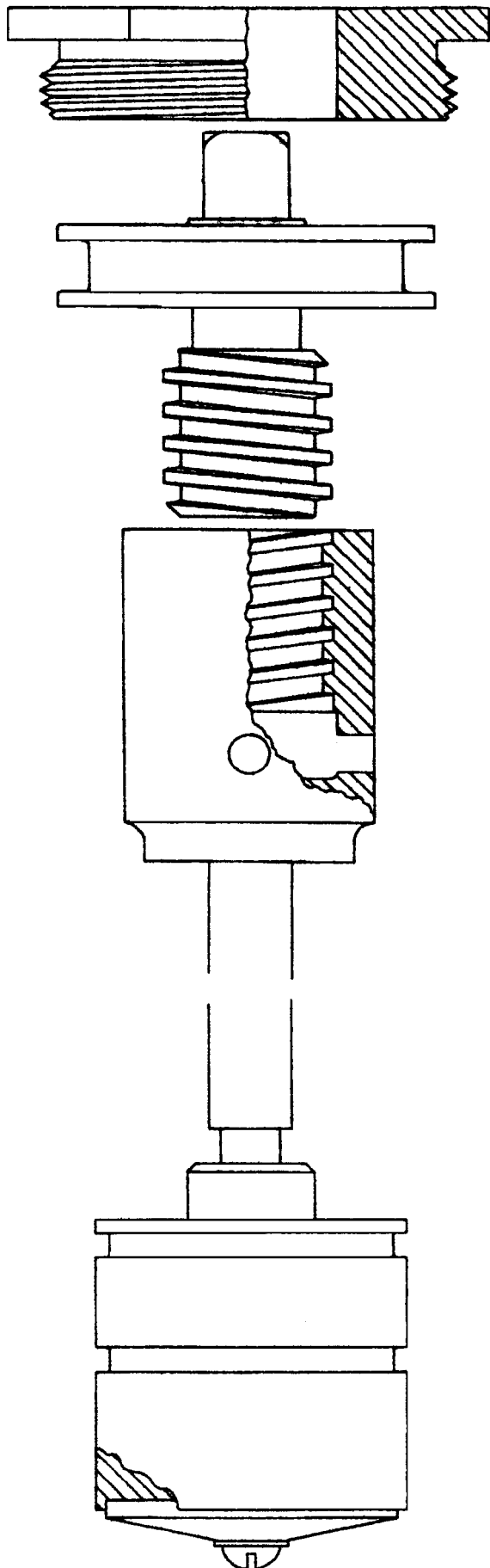

**Series Z-1365, Z-1390
freezeless ground & post hydrants**

94585
key (not pictured)

94586
operating screw

94587
operating coupling

94588
operator o-ring

94589
washer guide o-ring
(2 required)

94590
seat washer

94591
#11 screw

94582
removable seat (not pictured)

Repair kit:
94583
o-ring
o-ring (2)
operating screw
operating coupling
removable seat
seat washer
screw
key

